



LEARN2[®]
SEATING

PRICE LIST

EFFECTIVE SEPTEMBER 25, 2024
800.424.2432



| | |
|-------------------------------------------------------------|----|
| Ordering Customer's Own Material (C.O.M.) Upholstery | |
| Information | 3 |
| Learn2® Classroom Furniture | |
| General Information | 4 |
| Product Color Options | 8 |
| Learn2® Classroom Furniture (Freight Excluded) | |
| Doni® Seating with Worksurface | 9 |
| Intellect Wave® Seating with Worksurface | 13 |
| LimeLite™ Seating with Worksurface | 15 |
| Strive® Seating with Worksurface | 17 |
| Doni® Seating without Worksurface | 21 |
| Intellect Wave® Seating without Worksurface | 25 |
| LimeLite™ Seating without Worksurface | 27 |
| Strive® Seating without Worksurface | 29 |
| Learn2® Classroom Furniture (Delivered) | |
| Doni® Seating with Worksurface | 33 |
| Intellect Wave® Seating with Worksurface | 37 |
| LimeLite™ Seating with Worksurface | 39 |
| Strive® Seating with Worksurface | 41 |
| Doni® Seating without Worksurface | 45 |
| Intellect Wave® Seating without Worksurface | 49 |
| LimeLite™ Seating without Worksurface | 51 |
| Strive® Seating without Worksurface | 53 |



How to Specify

As a standard procedure, KI applies seating upholstery as swatched by the textile distributor. Reference distributor's website. Upholstery that is required to be applied differently than is swatched, will need a Product Modification Request written specifying the direction the upholstery is to be applied.

Seating upholstery requiring specific positioning of intricate patterns or patterns repeats on seats and backrests, will need a Product Modification Request written including a sketch noting the specific requirements, as in Diagram A.

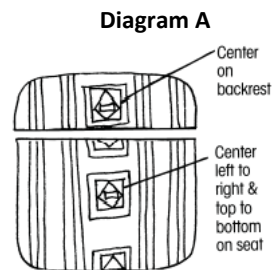

When directional or patterned fabrics are used, they often require more yardage than solid colors.

C.O.M. must be supplied in continuous yardage.

C.O.M. yardage requirements accompanying products in the pricing section are for 10 chairs/seats or less, 54" wide nondirectional material. On larger orders, less material is required.

Leather hides must be a minimum of 50 square feet of usable material. The outer edges cannot be calculated as square feet or yardage. To determine square footage, multiply unit yardage by 18 square feet to obtain the total square footage required per unit.

For exact production yardage requirements, call 1-800-424-2432, ext. 2707.

Production

Customer's upholstery must be approved prior to acceptance for production.

After approval, a memo swatch of the C.O.M. from the textile distributor must accompany the order. KI assumes no responsibility for wear, defects, or performance of C.O.M. upholstery.

C.O.M. not received into the appropriate facility 3 weeks prior to acknowledged delivery date may go on hold. See KI C.O.M. Shipping Location listing for the correct facility address by product.

Testing

When KI requires testing, actual yardage to upholster one chair may be required. The C.O.M. Specialist will confirm model and fabric testing requirements when applicable.

Approved test samples will be applied to the order or will be held for 6 months. After 6 months, the sample will no longer be applied to your order. For all product testing, send fabric samples to the manufacturing facility. See KI C.O.M. Shipping Location listing for the correct facility address by product.

All C.O.M. must be labeled with the KI product order number and customer purchase order number.

Treated Materials

If C.O.M. requires processing such as a stain resistance treatment or acrylic backing, it may shrink. To prevent delays in delivery or back ordering due to shrinkage, please have your processor verify measurement after processing and assure adequate yardage shipped.

Split Orders

If a portion of the shipment which does not require C.O.M. application is to be processed and shipped early, KI will enter the order immediately at your request. These split shipments are subject to minimum order changes.

Excess Upholstery Material

KI will dispose of excess upholstery material at the time of shipment unless expressly requested to return it with the product shipment.

Cancelled or Changed Orders

KI assumes no responsibility for extra C.O.M. due to a change of upholstery or cancellation of an order. If it the customer's responsibility to arrange for return of the material.

Contact the C.O.M. Specialist at 1-800-424-2432, ext. 2707, with questions or to request a split order.

C.O.M. SHIPPING LOCATION

Architectural Walls
Evoke..... MN
Genius Walls..... MN

Casegoods
Aristotle Tackboards.....MN
Likha Tackboards.....MN

Classroom Furniture
Intellect Wave Chairs..... GB
Learn2 GB
Ruckus.....GB

Desking
700 Series Desking KP
Balance Overheads MN
Genesis Desking..... MN
True Desking..... KP
Universal Overheads..... MN
WorkZone Desking MN

Files & Storage
700 Series Pedestal Cushion GB
Connection Zone Pads.....BW
U-Series Pedestal Cushion..... GB
Tattoo.....BW

Fixed Seating
Concerto Auditorium SeatingBW
Single Pedestal Seating GB
Jury Base Seating..... GB
Lancaster Auditorium SeatingBW
Sequence Seating..... GB
University Seating..... GB

Panel Systems
All Terrain..... KP
Balance Overheads MN

Universal Overheads..... MN
Wireworks MN
Unite..... MN

Residence Hall Furniture
RoomScope Furniture MN

Screens
All Terrain..... KP
Connection Zone.....BW
Tributaire.....BW
True/Volition KP
Genesis KP
Tattoo..... MN
Universal.....BW

Seating
600 Series Folding Chairs.....BW
600 Series StoolsBW
Affina Collection.....HN
Altus Task Chairs..... GB
Apply Stack Chairs GB
Calida Lounge SeatingHN
Diem Task Chairs OM
Doni Collection..... GB
Gladly Lounge SeatingVQ
Grazie Seating..... GB
Hub Modular Lounge SeatingHN
Impress Task Chairs..... OM
Impress Ultra Task Chairs OM
Jessa Lounge Seating.....HN
Jubilee Lounge Seating.....VQ
Katera..... GB
Kurv Benches.....HN
LimeLite..... GB
Lyra Lounge Seating.....HN
Medical & Laboratory Stools..... OM
MyPlace Lounge SeatingHN

MyWay Seating.....HN
Oath Task Chairs and Stools..... GB
Opt4 GB
Pilot Task Chairs..... OM
Promenade Seating SystemBW
Ruckus..... GB
Sela Lounge SeatingHN
Sift Task Chairs GB
Signia Task Chairs and StoolsOM
Soltice Metal Collection.....HN
Soltice Multiple, Healthcare & Guest .HN
Soltice II Healthcare Seating.....HN
SonrisaHN
Strive Multiple, Stack & Task GB
SwayBW
Tattoo.....HN
Torsion-on-the-Go! Nesting Chairs GB
Torsion Air Stack and Task Seating GB
ZekerHN
ZoetryHN



KI C.O.M. Manufacturing Site Addresses:

BW
KI Bonduel
Attn: COM Storage
204 West South St.
Bonduel, WI 54107

HN
KI High Point
Attn: COM Storage
217 Feld Avenue
High Point, NC 27263

MN
KI Manitowoc
Attn: COM Storage
1400 S. 41st St.
Manitowoc, WI 54220

VQ
KI
Attn: COM Fabrics
6892 Marlin Circle
La Palma, CA 90623

GB
KI Green Bay
Attn: COM Storage
1687 Westminster Drive - Gate 3
Green Bay, WI 54302

KP
KI Pembroke
Attn: COM Storage
1000 Olympic Dr.
Pembroke, Ontario K8A6X7

OM
KI
Attn: COM Storage
1110 S. Mildred Ave.
Ontario, CA 91761



TECHNICAL SPECIFICATIONS

Frame

Frame consists of 14-gauge, 1" diameter steel tubing, bent and welded to a 13-gauge steel stamped seat plate, and finished with baked-on powder-coat paint. The chair frame is topped by two aluminum die castings with a baked-on black powder-coated finish. Castings support the unit's seat and provide a means of rotation of the tablet about the seat.

Shell

Döni®

The backrest and seat are injection-molded polypropylene. The seat and backrest are joined by a pair of hidden articulation mechanisms, each consisting of a 14-gauge steel housing, twin 7-gauge levers and steel coil springs. While maintaining a one-piece shell appearance, this mechanism allows the backrest to recline up to 17 degrees of motion.

Under-seat structure is a die-drawn 12-gauge steel plate. Structure is finished with baked-on electrostatically-applied 30-degree gloss epoxy powder-coat paint.

The Doni shell is designed by Giancarlo Piretti.

Upholstered Seat (optional)

Urethane foam is attached to an injection-molded polypropylene liner board, then upholstered using a draw-string process. Seat foam is molded nominal 1" thickness.

Intellect Wave®

One-piece contoured shell is made of high-impact polypropylene. Colorfastness ensured through complete color impregnation throughout the molded part. Strength and durability is assured through an engineered internal structural cavity which eliminates the need for unsightly ribs on the back of the shell. Shells have rolled edges for comfort and strength, textured front and back, with a wide, ergonomic handle molded into the chair back. Shell fastens to the chair by a 12-gauge formed steel plate with six Torx screws.

Upholstered Seat (optional)

Upholstered chairs have partially exposed polypropylene surfaces. Fabric is upholstered over $\frac{9}{16}$ " foam on the seat and fastened to an inner shell with screws.

LimeLite®

The seat and backrest are integrated into a single shell that is injection-molded in polypropylene, reinforced with glass fiber. The shell is ergonomically contoured and features a passive-flex back movement for superior comfort.

Upholstered Seat (optional)

Molded urethane foam is attached to an injection molded polypropylene seat board, then upholstered using a draw-string process. The assembled seat pad is attached to the seat by means of hidden fasteners. Seat foam is nominal $\frac{1}{4}$ " thickness.

Strive®

Injection molded polypropylene back with integral steel cantilever springs. The combination of the slotted polypropylene back and the spring steel construction provides a supportive flexing back. Springs are nominal 4.5 mm diameter chrome silicon valve spring wire. Injection molded polypropylene seat is secured to the chair by a 12-gauge formed steel plate.

The Strive shell is designed by Giancarlo Piretti.

The chair shell (either option) swivels a total of 55 degrees (27.5 degrees each way from center) for ease of entry and exit.

TECHNICAL SPECIFICATIONS

Upholstered Seat (optional)

Molded urethane foam is attached to an injection molded polypropylene seat board, then upholstered using a draw-string process. The assembled seat pad is attached to the seat by means of hidden fasteners.

Arms (optional)

When equipped with optional cantilever arms, the supporting structure is $\frac{7}{8}$ " diameter by 13-gauge tubular steel, welded directly to the seat support structure, and matching the seat and back color. The armcaps are injection-molded glass filled polypropylene matching the seat and back color. Armcaps are attached to the steel structure by means of screws.

Surface Support

The worksurface is supported from the chair frame by a formed and welded support tube made from $1\frac{1}{8}$ " diameter, 14-gauge steel. The worksurface is supported from the support tube by an aluminum gusset die casting with a black powder-coated paint finish. The support tube rotates around the chair seat a total of 220 degrees (110 degrees each way from front-center). A $\frac{1}{2}$ " thick steel plug is drilled, tapped, and welded into the end of the support tube. The worksurface is structurally secured to the support tube with a Grade 5, $\frac{3}{8}$ -16 bolt, held secure with an epoxy patch.

Surface Mechanism

The gusset die casting rotates about the support tube by means of a plastic bushing connection, rotating a total of 154 degrees around the support tube (77 degrees each way from center). The worksurface slides back and forth for a total of 6" of straight in-and-out movement. The sliding motion is accomplished with an aluminum extruded rail and plastic bushing mechanism.

Surface

The worksurface measures 13" x 21 $\frac{1}{2}$ " for a writing surface area of 280 square inches.

Plastic

The writing surface of the plastic worksurface is injection molded ABS and includes two pencil grooves and a thumb guide. The understructure of the plastic worksurface is injection molded nylon with fiberglass reinforcement filling. Top surface available in Black, Flannel, or Warm Grey; bottom understructure is Black only.

Laminate

The laminate worksurface is 18 mm thick Baltic Birch plywood core with .040" laminate face and .020" paper backing sheet. The edge of the wood surface is shaped and sanded with a sealed and clear coat lacquered finish. KI standard laminates available (see Color Addendum).

Optional Accessory Racks

Accessory Rack (with or without cupholder)

Racks are constructed of 14-gauge perforated steel wrapped with $\frac{1}{4}$ " diameter steel wire and are welded to the frame. Optional cup holders are made of a $\frac{1}{4}$ " diameter steel wire, welded with an 11-gauge flat metal round trim plate to the steel racks. Accessory racks (with or without cupholder) are not field installable or retrofittable.

Flat Accessory Rack

Rack is constructed of 16-gauge perforated steel wrapped with $\frac{1}{4}$ " diameter steel wire welded to the frame. The rack is reinforced with stiffener channels that are constructed of 14-gauge cold rolled steel that are welded to the perforated steel rack assembly. The rack is fastened to weldments on the chair frame using #10-24 x $\frac{1}{2}$ " PEM self-clinching studs, #10-24 hex nuts and lock washers. The flat accessory rack is not field installable or retrofittable.

Poly Bookbag Rack

Rack is constructed of injection molded polypropylene and has a textured finish. It fastens to the chair using four #12 x $\frac{3}{8}$ " Truss head screws and has a molded-in cupholder and two accessory slots.

Casters and Glides

Casters are double wheels (60 mm) of high-impact thermoplastic with high impact plastic frame. Carpet or hard floor casters, Black only.

Optional Bell glides (2" high) made of high-impact plastic also available, Black only.



DIMENSIONS

Doni® Seating

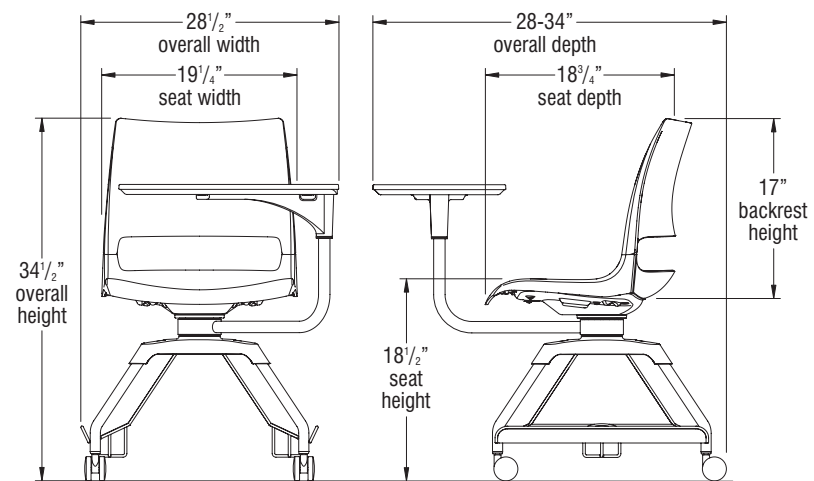

Intellect Wave® Seating

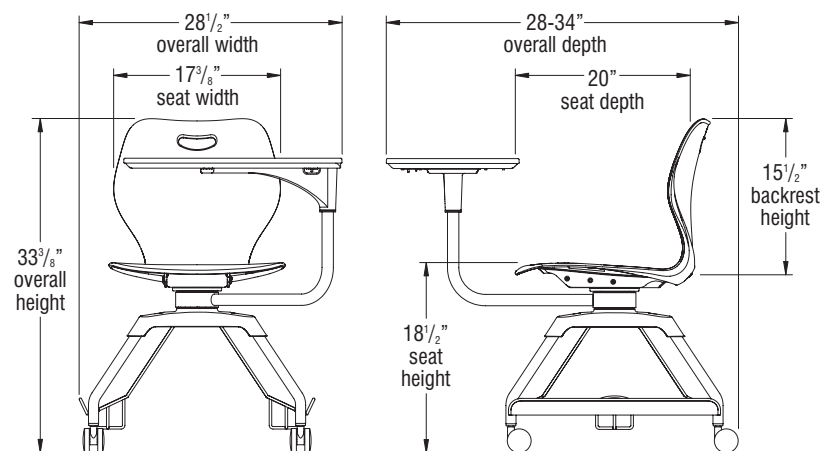

LimeLite® Seating

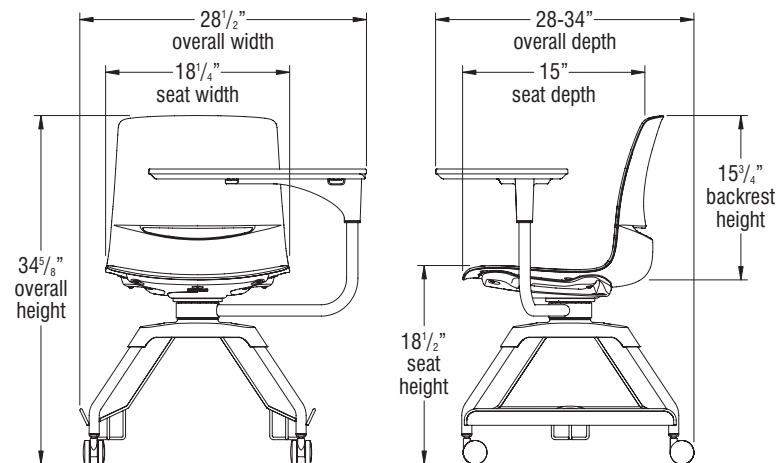

DIMENSIONS

Strive® Seating

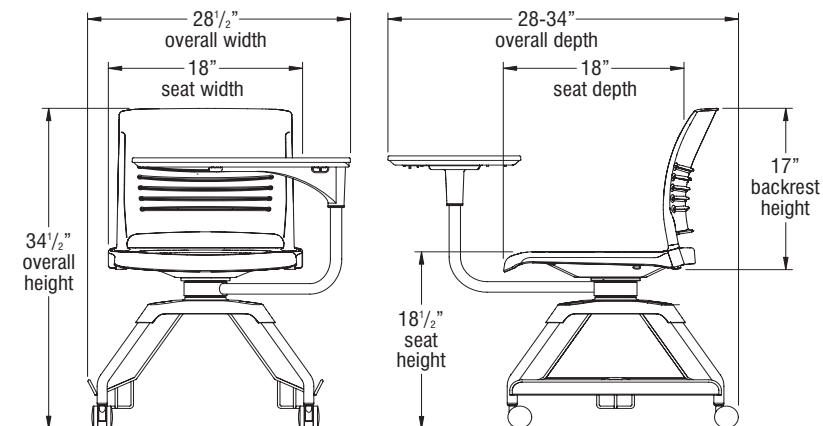

Learn2® Seating Tablet Arm

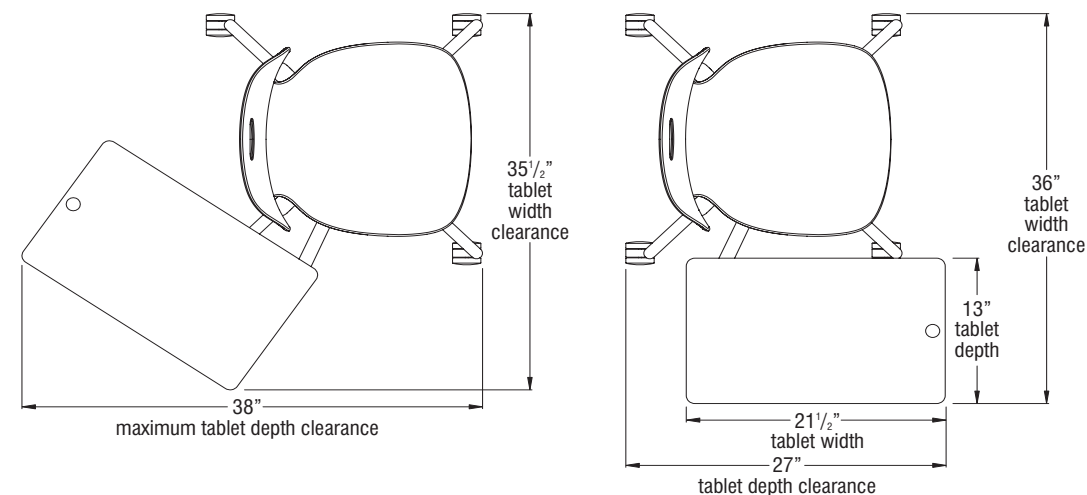
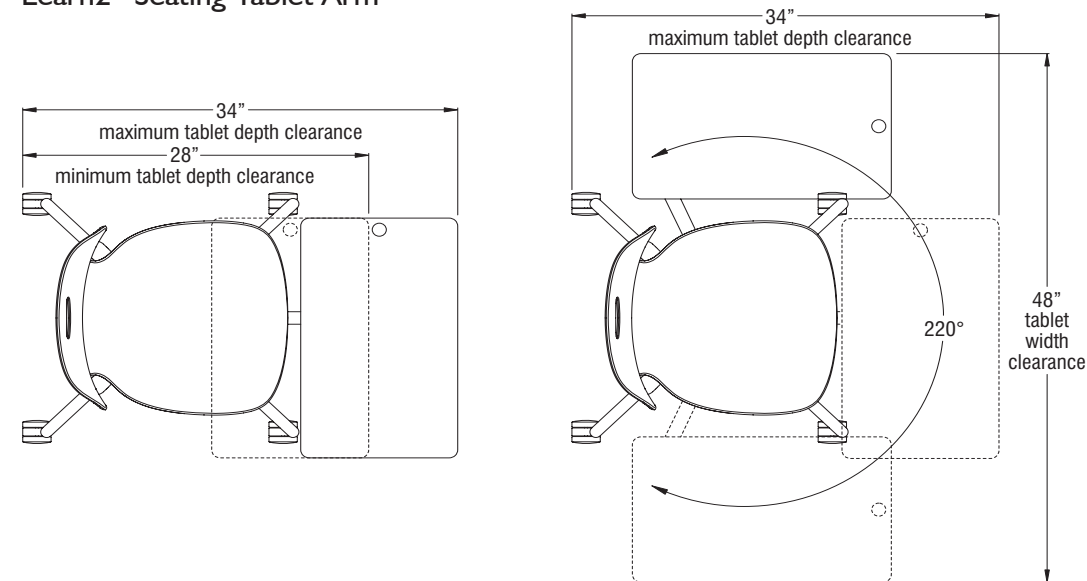



DIMENSIONS

Learn2® Seating Tablet Arm

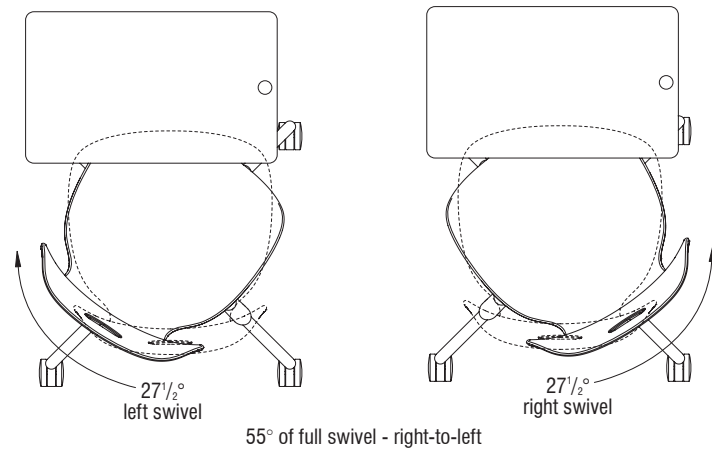

STATEMENT OF LINE

Doni® Seating

All models are available in polypropylene seat/backrest, upholstered seat/ polypropylene backrest, or upholstered seat/backrest.

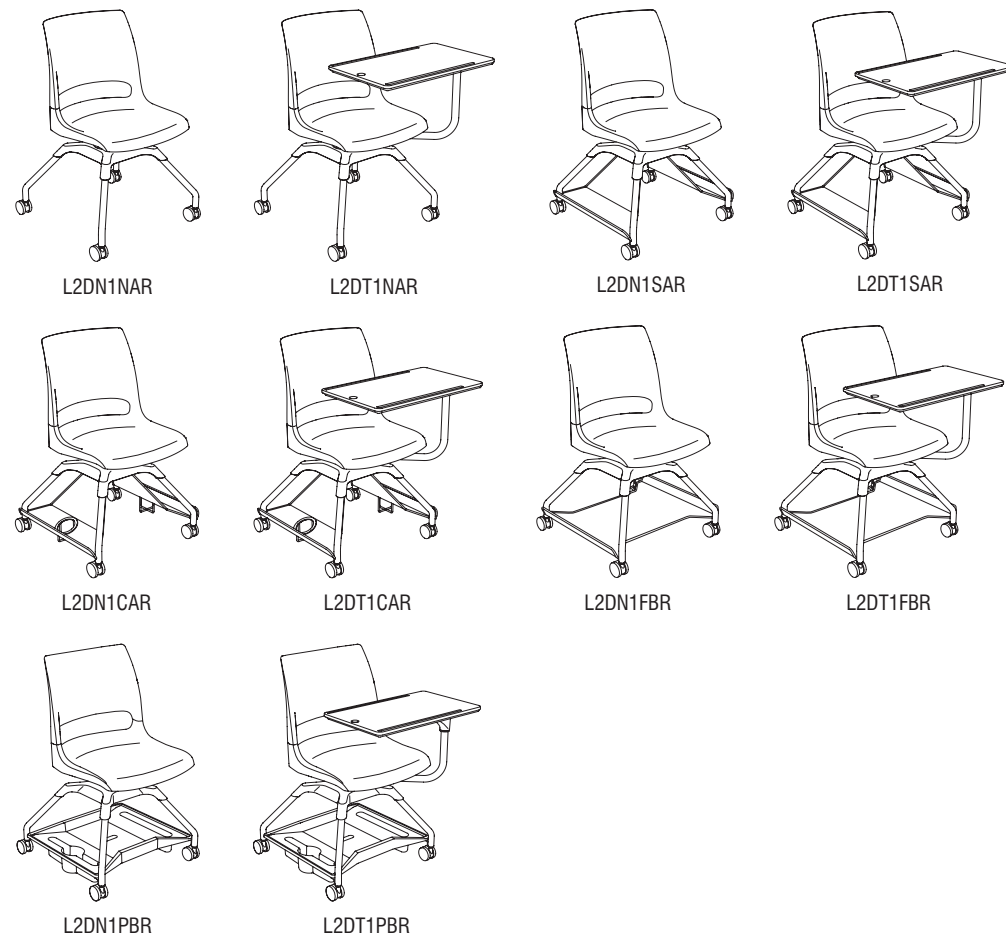

STATEMENT OF LINE

Intellect Wave® Seating

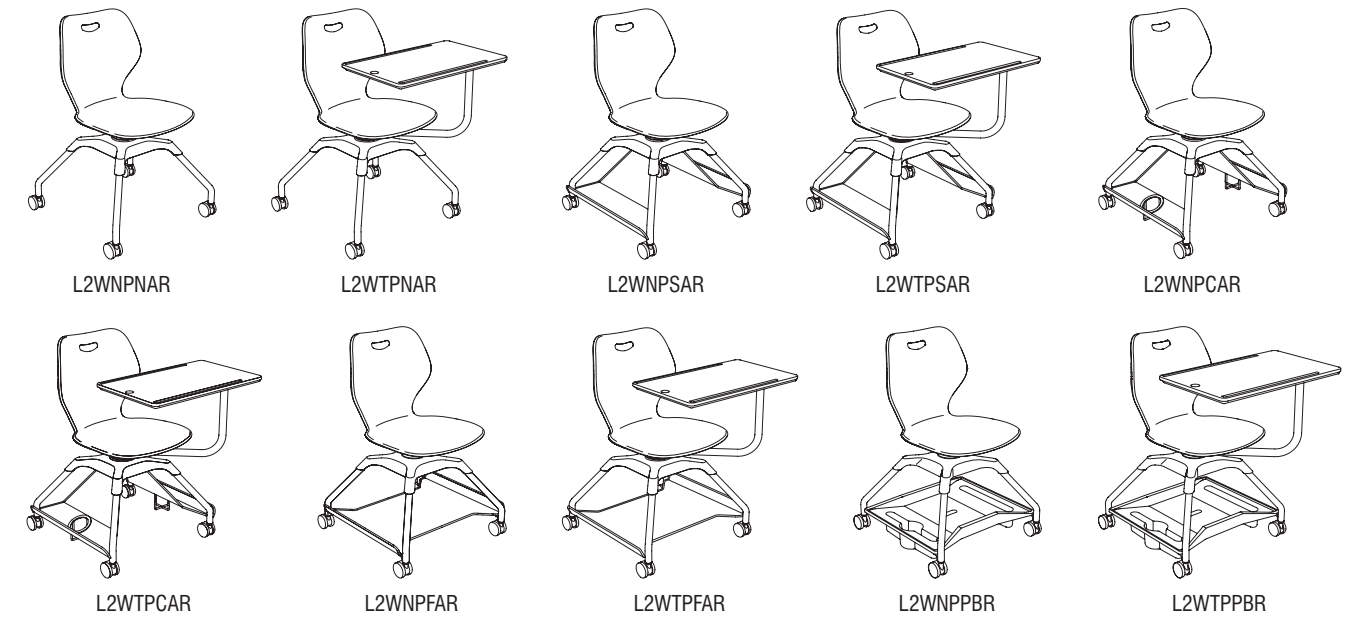

Limelite® Seating

All models are available in polypropylene seat/backrest, upholstered seat/ polypropylene backrest, or upholstered seat/backrest

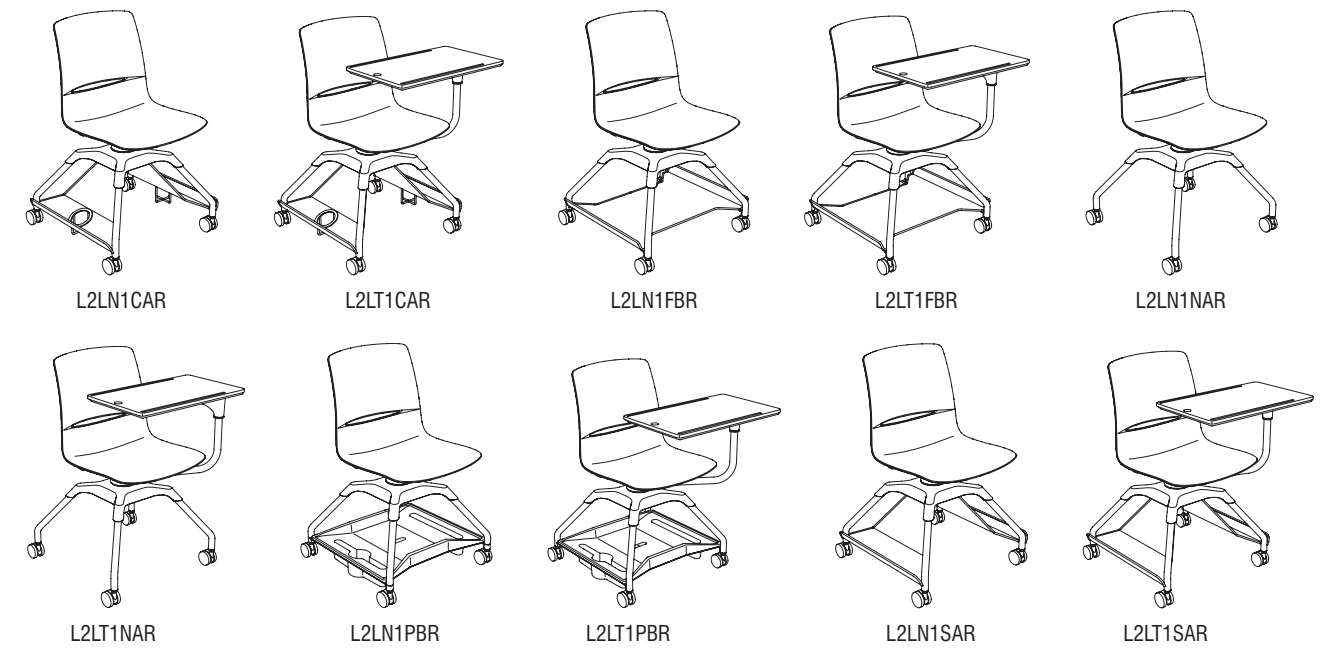

STATEMENT OF LINE

Strive® Seating

All models are available in polypropylene seat/backrest, upholstered seat/ polypropylene backrest, or upholstered seat/backrest.

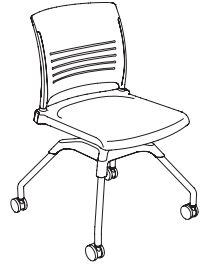

L2SNPNANAR



L2STPNANAR



L2SNPCANAR

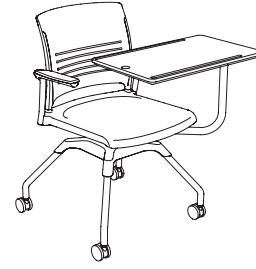

L2STPCANAR



L2SNPNASAR



L2STPNASAR



L2SNPCASAR



L2STPCASAR



L2SNPNACAR

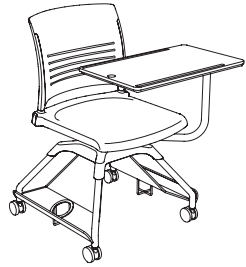

L2STPNACAR



L2SNPCACAR



L2STPCACAR



L2SNPNAFAR



L2STPNAFAR

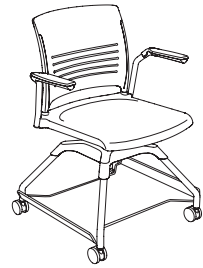

L2SNPCAFAR



L2STPCAFAR



L2SNPNAPBR



L2STPNAPBR



L2SNPNAPBR



L2STPCAPBR



| | | | |
|----------------|----|--------------------|-----|
| Learn2® | | Cherry Storm | LCX |
| | | Classic Linen | LCI |
| | | Cloud Zephyr | LCL |
| | | Cocobala | LCC |
| | BL | Crisp Linen | LRI |
| | GR | Desert Zephyr | LDZ |
| | ZM | Designer White | LDR |
| | CY | Dove Grey | LDG |
| | CM | Flax Linen | LXF |
| | CG | Florence Walnut | LFC |
| | CO | Forged Steel | LOL |
| | EY | Friston Ash | LFH |
| | EX | Frosty White | LFW |
| | EV | Graphite Nebula | LGN |
| | FN | Grey | LGE |
| | GZ | High Rise | LHE |
| | HJ | Hollyberry | LHY |
| | HY | Island | LID |
| | LG | Italian Silver Ash | LIT |
| | MG | Kensington Maple | LKM |
| | MY | Lapis Blue | LLB |
| | NE | Markerboard White | LMK |
| | ND | Misted Zephyr | LMR |
| | PR | Monticello Maple | LMT |
| | PH | North Sea | LNA |
| | PG | Ocean | LON |
| | RQ | Pearl Bisque | LPB |
| | RJ | Pinnacle Walnut | LPW |
| | RK | Pressed Linen | LPR |
| | SA | River Cherry | LRY |
| | SK | Satin Stainless | LSS |
| | SX | Shadow Zephyr | LSR |
| | SX | Silicon evolv | LSV |
| | SP | Sterling Ash | LSV |
| | TQ | Tailored Linen | LAZ |
| | TI | Titanium evolv | LTL |
| | UB | White Nebula | LTV |
| | WG | White Sand | LWL |
| | ZL | Windsor Mahogany | LWN |
| | | | LWY |

Additional colors may be available. Please contact KI customer service at 1-800-424-2432.

Surface Color - Plastic Colors

| | |
|-----------|------|
| Black | BLWS |
| Warm Grey | WGWS |
| Flannel | FNWS |

Additional colors may be available. Please contact KI customer service at 1-800-424-2432.

Surface Finish - Laminate Colors

| | |
|-----------------|-----|
| Beigewood | LBZ |
| Belair | LBQ |
| Biltmore Cherry | LBT |
| Black | LBK |
| Brighton Walnut | LBW |
| Canyon Zephyr | LCA |
| Castle Oak | LCO |
| Casual Linen | LCU |

Learn2 - Doni

SOLID COLOR Seat and Back - Polypropylene Non Flame-Retardant

| | |
|-----------------|-----|
| Black | PBL |
| Blue Grey | PGR |
| Cool Grey | PCG |
| Cottonwood | PCO |
| Earthen Clay | PEY |
| Everglade Shade | PEV |
| Flannel | PFN |
| Hazy Jade | PHJ |
| Honey Bee | PHY |
| Light Tone | PLG |
| Mardi Gras | PMG |
| Misty Brown | PMY |
| Nemo | PNE |
| Nordic | PND |
| Poppy Red | PPR |

| | |
|-----------------|-----|
| Rainforest | PRQ |
| Raw Jasper | PRJ |
| Surf's Up | PSP |
| Tarragon | PTQ |
| Twilight Shadow | PTI |
| Ultra Blue | PUB |
| Warm Grey | PWG |
| Zesty Lime | PZL |

SOLID COLOR Seat and Back - Polypropylene Flame-Retardant

| | |
|-------|-----|
| Black | PBL |
|-------|-----|

The above seating product can be manufactured using the appropriate flame-retardant materials for compliance of California Technical Bulletin 133.

TWO-TONE COLOR Seat and Back - Polypropylene Non Flame-Retardant

Outside / Inside

| | |
|---------------------------------------|---------|
| Outside Black/Inside Cottonwood | OBL/ICO |
| Outside Blue Grey/Inside Cool Grey | OGR/ICG |
| Outside Blue Grey/Inside Cottonwood | OGR/ICO |
| Outside Cool Grey/Inside Cottonwood | OCG/ICO |
| Outside Flannel/Inside Warm Grey | OFN/IWG |
| Outside Misty Brown/Inside Cottonwood | OMY/ICO |
| Outside Nemo/Inside Cottonwood | ONE/ICO |
| Outside Nordic/Inside Cool Grey | OND/ICG |
| Outside Poppy Red/Inside Cottonwood | OPR/ICO |
| Outside Surf's Up/Inside Cool Grey | OSP/ICG |
| Outside Ultra Blue/Inside Cottonwood | OUB/ICO |
| Outside Zesty Lime/Inside Cottonwood | OZL/ICO |

Learn2® - Intellect Wave®, LimeLite™ and Strive®

Seat and Back Color - Poly Non Flame- Retardant for Upholstered and Non-Upholstered

| | |
|-----------------|-----|
| Black | PBL |
| Blue Grey | PGR |
| Cayenne | PCY |
| Cool Grey | PCG |
| Cottonwood | PCO |
| Earthen Clay | PEY |
| Everglade Shade | PEV |
| Flannel | PFN |
| Hazy Jade | PHJ |
| Honey Bee | PHY |
| Light Tone | PLG |
| Mardi Gras | PMG |
| Misty Brown | PMY |
| Nemo | PNE |
| Nordic | PND |
| Poppy Red | PPR |
| Purple Haze | PPH |
| Rainforest | PRQ |
| Raw Jasper | PRJ |
| Rubber Ducky | PRK |
| Sand | PSA |

| | |
|-----------------|-----|
| Sky Blue | PSK |
| Surf's Up | PSP |
| Tarragon | PTQ |
| Twilight Shadow | PTI |
| Ultra Blue | PUB |
| Warm Grey | PWG |
| Zesty Lime | PZL |

Seat and Back Color - Polypropylene Flame- Retardant for Upholstered and Non-Upholstered

| | |
|-------|-----|
| Black | PBL |
|-------|-----|

The above seating product can be manufactured using the appropriate flame-retardant materials for compliance to California Technical Bulletin 133.

Strive armcaps and glides match the frame color with the following exceptions below:

When frame color is metallic, the armcaps and glides will match poly color.

When frame color is metallic, and the poly color is translucent diamond, the armcaps will be light tone.

When frame color is metallic, and the poly color is translucent pewter, the armcaps will be flannel.

Finish Cards

View color swatches for items listed within this document.

Paints

Plastics/Poly

Wood/Veneer

Laminates

Molded Edges

Edge Styles

Hard Plastics

Glass

Certain options referenced may not be available on GSA Schedule.



Learn2® Classroom Furniture (Freight Excluded)

Doni® Seating with Worksurface



Learn2® Classroom Furniture (Freight Excluded)

Doni® Seating with Worksurface

| Features | MODEL NUMBER | | | | | | | | | | Approx. Packaged Weight | Freight Excluded Pricing Upholstered | Freight Excluded Pricing Fabric Grade 1, C.O.M. & COV | Freight Excluded Pricing Fabric Grade 2 | Freight Excluded Pricing Fabric Grade 3 & Group 2V Vinyl | Freight Excluded Pricing Pallas Fabric Group P0 | Freight Excluded Pricing Pallas Fabric Group P1 | Freight Excluded Pricing Pallas Fabric Group P2 | Freight Excluded Pricing Pallas Fabric Group P3 | Freight Excluded Pricing Pallas Fabric Group P4 | |
|--------------------------------------------------------------------------------------------------------------|--------------|--------------------------|--------------------------|--------------------------|--------------------------|---------------------------|------------------------------|--------------------------|--------------------------|--|-------------------------|--------------------------------------|-------------------------------------------------------|-----------------------------------------|----------------------------------------------------------|-------------------------------------------------|-------------------------------------------------|-------------------------------------------------|-------------------------------------------------|-------------------------------------------------|--|
| | Basic Model | Surface Type | Frame Color | Fire Code | Poly Solid Color | Poly Outside/Inside Color | Surface Finish/Plastic Color | Glide Option | Uph. Color | | | | | | | | | | | | |
|  Solid Color, Polypropylene | L2DT1/NAR | <input type="checkbox"/> | <input type="checkbox"/> | <input type="checkbox"/> | <input type="checkbox"/> | | <input type="checkbox"/> | <input type="checkbox"/> | | | 57.0# | \$ 819 | | | | | | | | | |
| Solid Color, Upholstered Seat | L2DT2/NAR | <input type="checkbox"/> | <input type="checkbox"/> | <input type="checkbox"/> | <input type="checkbox"/> | | <input type="checkbox"/> | <input type="checkbox"/> | <input type="checkbox"/> | | 57.0# | N/A | 954 | 966 | 984 | 995 | 1042 | 1059 | 1083 | 1116 | |
| Two-Tone, Polypropylene | L2DTA/NAR | <input type="checkbox"/> | <input type="checkbox"/> | NFR | | <input type="checkbox"/> | <input type="checkbox"/> | <input type="checkbox"/> | | | 57.0# | 884 | | | | | | | | | |
| Two-Tone, Upholstered Seat | L2DTB/NAR | <input type="checkbox"/> | <input type="checkbox"/> | NFR | | <input type="checkbox"/> | <input type="checkbox"/> | <input type="checkbox"/> | <input type="checkbox"/> | | 57.0# | N/A | 1021 | 1028 | 1050 | 1059 | 1105 | 1124 | 1146 | 1179 | |
| 2DWS1 | | | | | | | | | | | | | | | | | | | | | |
| 2DWS2 | | | | | | | | | | | | | | | | | | | | | |
| 2DWSA | | | | | | | | | | | | | | | | | | | | | |
| 2DWSB | | | | | | | | | | | | | | | | | | | | | |
| Without Accessory Rack | | | | | | | | | | | | | | | | | | | | | |
| • Non-handed worksurface in choice of plastic or laminate | | | | | | | | | | | | | | | | | | | | | |
| • Solid or two-tone colored shell | | | | | | | | | | | | | | | | | | | | | |
| • Unlimited color match's | | | | | | | | | | | | | | | | | | | | | |
| • 17 degrees of hip articulation | | | | | | | | | | | | | | | | | | | | | |
|  Solid Color, Polypropylene | L2DT1/SAR | <input type="checkbox"/> | <input type="checkbox"/> | <input type="checkbox"/> | <input type="checkbox"/> | | <input type="checkbox"/> | <input type="checkbox"/> | | | 57.0# | \$ 846 | | | | | | | | | |
| Solid Color, Upholstered Seat | L2DT2/SAR | <input type="checkbox"/> | <input type="checkbox"/> | <input type="checkbox"/> | <input type="checkbox"/> | | <input type="checkbox"/> | <input type="checkbox"/> | <input type="checkbox"/> | | 57.0# | N/A | 982 | 993 | 1012 | 1022 | 1068 | 1086 | 1110 | 1143 | |
| Two-Tone, Polypropylene | L2DTA/SAR | <input type="checkbox"/> | <input type="checkbox"/> | NFR | | <input type="checkbox"/> | <input type="checkbox"/> | <input type="checkbox"/> | | | 57.0# | 910 | | | | | | | | | |
| Two-Tone, Upholstered Seat | L2DTB/SAR | <input type="checkbox"/> | <input type="checkbox"/> | NFR | | <input type="checkbox"/> | <input type="checkbox"/> | <input type="checkbox"/> | <input type="checkbox"/> | | 57.0# | N/A | 1046 | 1057 | 1076 | 1086 | 1132 | 1151 | 1174 | 1206 | |
| 2DWS1 | | | | | | | | | | | | | | | | | | | | | |
| 2DWS2 | | | | | | | | | | | | | | | | | | | | | |
| 2DWSA | | | | | | | | | | | | | | | | | | | | | |
| 2DWSB | | | | | | | | | | | | | | | | | | | | | |
| Accessory Rack | | | | | | | | | | | | | | | | | | | | | |
| • Non-handed worksurface in choice of plastic or laminate | | | | | | | | | | | | | | | | | | | | | |
| • Accessory rack included on both sides of frame | | | | | | | | | | | | | | | | | | | | | |
| • Solid or two-tone colored shell | | | | | | | | | | | | | | | | | | | | | |
| • Unlimited color match's | | | | | | | | | | | | | | | | | | | | | |
| • 17 degrees of hip articulation | | | | | | | | | | | | | | | | | | | | | |

A B C D E F G H I

HOW TO ORDER

- Indicate the following information on order form:
- Quantity of each item.
 - Model number, including options. See "How To Build a Model Number".
 - Any special service required.

Note: • The indicates that a choice is required.
 • The absence of the indicates that no choice is required.
 • Alpha-numeric characters in place of indicate that no other alternatives are available.

HOW TO BUILD A MODEL NUMBER

- A** Select basic model.
- B** Select worksurface type.

| | |
|-----------|----------------------------------|
| LW | - Laminate worksurface; add \$60 |
| PW | - Plastic worksurface |
- C** Select frame color.
Refer to the **Product Color Options** page in this price list.
- D** Select fire code.

| | |
|------------|-----------------------------|
| NFR | - Compliance to TB 117-2013 |
| FR | - Compliance to TB 133 |
- E** Select solid poly color.
Refer to the **Product Color Options** page in this price list.
- F** Select outside/inside poly color.
Refer to the **Product Color Options** page in this price list.
- G** Select surface finish.

- Refer to the **Product Color Options** page in this price list.
- H** Select caster/glide option.

| | |
|------------|-----------------------------------------|
| C | - Carpet casters |
| S | - Hard floor casters |
| GL | - Glides |
| SCG | - Front hard floor casters, rear glides |
| CCG | - Front carpet casters, rear glides |
 - I** Select upholstery grade/color.
Refer to ki.com/fabrics

UPHOLSTERY INFORMATION

C.O.M. Upholstery
 C.O.M. requirement for 10 chairs or less with upholstered seat or upholstered seat and back is 3/4 yard per chair of 54" wide nondirectional fabric. For orders of 11 or more with upholstered seat and back and for complete information on ordering C.O.M. see "Ordering C.O.M., C.O.V. and C.O.L." section.

California TB133 Fire Safety Code
 For California Technical Bulletin 133 compliant models, add the following upcharge:
 Model=Solid Color, Polypropylene
 Added List Price=\$13
 Model=Solid Color, Upholstered Seat
 Added List Price=\$81

SPECIAL SERVICES

Special Carton Marking

With specially marked information N/C

Shipping
 Ships assembled, FOB Green Bay, WI 54302, freight excluded. Freight class 300.

Specifications and prices are subject to change without prior notice.

Learn2® Classroom Furniture (Freight Excluded)

Doni® Seating with Worksurface



Learn2® Classroom Furniture (Freight Excluded)

Doni® Seating with Worksurface

| Features | MODEL NUMBER | | | | | | | | | | Approx. Packaged Weight | Freight Excluded Pricing Unupholstered | Freight Excluded Pricing Fabric Grade 1, C.O.M. & COV | Freight Excluded Pricing Fabric Grade 2 | Freight Excluded Pricing Fabric Grade 3 & Group 2V Vinyl | Freight Excluded Pricing Pallas Fabric Group P0 | Freight Excluded Pricing Pallas Fabric Group P1 | Freight Excluded Pricing Pallas Fabric Group P2 | Freight Excluded Pricing Pallas Fabric Group P3 | Freight Excluded Pricing Pallas Fabric Group P4 | |
|-------------------------------|--------------|--------------------------|--------------------------|--------------------------|--------------------------|---------------------------|------------------------------|--------------------------|--------------------------|--|-------------------------|----------------------------------------|-------------------------------------------------------|-----------------------------------------|----------------------------------------------------------|-------------------------------------------------|-------------------------------------------------|-------------------------------------------------|-------------------------------------------------|-------------------------------------------------|--|
| | Basic Model | Surface Type | Frame Color | Fire Code | Poly Solid Color | Poly Outside/Inside Color | Surface Finish/Plastic Color | Glide Option | Uph. Color | | | | | | | | | | | | |
| Solid Color, Polypropylene | L2DT1/CAR | <input type="checkbox"/> | <input type="checkbox"/> | <input type="checkbox"/> | <input type="checkbox"/> | | <input type="checkbox"/> | <input type="checkbox"/> | | | 57.0# | \$ 890 | | | | | | | | | |
| Solid Color, Upholstered Seat | L2DT2/CAR | <input type="checkbox"/> | <input type="checkbox"/> | <input type="checkbox"/> | <input type="checkbox"/> | | <input type="checkbox"/> | <input type="checkbox"/> | <input type="checkbox"/> | | 57.0# | N/A | 1025 | 1037 | 1055 | 1064 | 1112 | 1129 | 1153 | 1187 | |
| Two-Tone, Polypropylene | L2DTA/CAR | <input type="checkbox"/> | <input type="checkbox"/> | NFR | | <input type="checkbox"/> | <input type="checkbox"/> | <input type="checkbox"/> | | | 57.0# | 953 | | | | | | | | | |
| Two-Tone, Upholstered Seat | L2DTB/CAR | <input type="checkbox"/> | <input type="checkbox"/> | NFR | | <input type="checkbox"/> | <input type="checkbox"/> | <input type="checkbox"/> | <input type="checkbox"/> | | 57.0# | N/A | 1088 | 1101 | 1119 | 1129 | 1176 | 1195 | 1217 | 1249 | |
| | | | | | | | | | | | | | | | | | | | | | |
| | | | | | | | | | | | | | | | | | | | | | |
| | | | | | | | | | | | | | | | | | | | | | |
| | | | | | | | | | | | | | | | | | | | | | |
| | | | | | | | | | | | | | | | | | | | | | |
| | | | | | | | | | | | | | | | | | | | | | |
| | | | | | | | | | | | | | | | | | | | | | |
| | | | | | | | | | | | | | | | | | | | | | |
| | | | | | | | | | | | | | | | | | | | | | |
| | | | | | | | | | | | | | | | | | | | | | |
| | | | | | | | | | | | | | | | | | | | | | |
| | | | | | | | | | | | | | | | | | | | | | |
| | | | | | | | | | | | | | | | | | | | | | |



- 2DWS1
- 2DWS2
- 2DWSA
- 2DWSB

- Cup Holder/Accessory Rack**
- Non-handed worksurface in choice of plastic or laminate
 - Cup holder/accessory rack included on both sides of frame
 - Solid or two-tone colored shell
 - Unlimited color match's
 - 17 degrees of hip articulation

HOW TO ORDER

- Indicate the following information on order form:
- Quantity of each item.
 - Model number, including options. See "How To Build a Model Number".
 - Any special service required.

Note: • The indicates that a choice is required.
 • The absence of the indicates that no choice is required.
 • Alpha-numeric characters in place of indicate that no other alternatives are available.

HOW TO BUILD A MODEL NUMBER

- A** Select basic model.
- B** Select worksurface type.
 LW - Laminate worksurface; add \$60
 PW - Plastic worksurface
- C** Select frame color.
 Refer to the **Product Color Options** page in this price list.
- D** Select fire code.
 NFR - Compliance to TB 117-2013
 FR - Compliance to TB 133
- E** Select solid poly color.
 Refer to the **Product Color Options** page in this price list.
- F** Select outside/inside poly color.
 Refer to the **Product Color Options** page in this price list.
- G** Select surface finish.

Refer to the **Product Color Options** page in this price list.

- H** Select caster/glide option.
 C - Carpet casters
 S - Hard floor casters
 GL - Glides
 SCG - Front hard floor casters, rear glides
 CCG - Front carpet casters, rear glides

I Select upholstery grade/color.
 Refer to ki.com/fabrics

UPHOLSTERY INFORMATION

C.O.M. Upholstery
 C.O.M. requirement for 10 chairs or less with upholstered seat or upholstered seat and back is 3/4 yard per chair of 54" wide nondirectional fabric. For orders of 11 or more with upholstered seat and back and for complete information on ordering C.O.M. see "Ordering C.O.M., C.O.V. and C.O.L." section.

California TB133 Fire Safety Code
 For California Technical Bulletin 133 compliant models, add the following upcharge:
 Model=Solid Color, Polypropylene
 Added List Price=\$13
 Model=Solid Color, Upholstered Seat
 Added List Price=\$81

SPECIAL SERVICES

Special Carton Marking
 With specially marked information N/C

Shipping
 Ships assembled, FOB Green Bay, WI 54302, freight excluded. Freight class 300.

Specifications and prices are subject to change without prior notice.

Learn2® Classroom Furniture (Freight Excluded)

Doni® Seating with Worksurface



Learn2® Classroom Furniture (Freight Excluded)

Doni® Seating with Worksurface

| Features | MODEL NUMBER | | | | | | | | | Approx. Packaged Weight | Freight Excluded Pricing Upholstered | Freight Excluded Pricing Fabric Grade 1, C.O.M. & COV | Freight Excluded Pricing Fabric Grade 2 | Freight Excluded Pricing Fabric Grade 3 & Group 2V Vinyl | Freight Excluded Pricing Pallas Fabric Group P0 | Freight Excluded Pricing Pallas Fabric Group P1 | Freight Excluded Pricing Pallas Fabric Group P2 | Freight Excluded Pricing Pallas Fabric Group P3 | Freight Excluded Pricing Pallas Fabric Group P4 |
|-------------------------------|--------------|--------------------------|--------------------------|--------------------------|--------------------------|---------------------------|------------------------------|--------------------------|--------------------------|-------------------------|--------------------------------------|-------------------------------------------------------|-----------------------------------------|----------------------------------------------------------|-------------------------------------------------|-------------------------------------------------|-------------------------------------------------|-------------------------------------------------|-------------------------------------------------|
| | Basic Model | Surface Type | Frame Color | Fire Code | Poly Solid Color | Poly Outside/Inside Color | Surface Finish/Plastic Color | Glide Option | Uph. Color | | | | | | | | | | |
| Solid Color, Polypropylene | L2DT1/PBR | <input type="checkbox"/> | <input type="checkbox"/> | <input type="checkbox"/> | <input type="checkbox"/> | | <input type="checkbox"/> | <input type="checkbox"/> | | 57.0# | \$ 868 | | | | | | | | |
| Solid Color, Upholstered Seat | L2DT2/PBR | <input type="checkbox"/> | <input type="checkbox"/> | <input type="checkbox"/> | <input type="checkbox"/> | | <input type="checkbox"/> | <input type="checkbox"/> | <input type="checkbox"/> | 57.0# | N/A | 1003 | 1014 | 1034 | 1044 | 1091 | 1109 | 1131 | 1165 |
| Two-Tone, Polypropylene | L2DTA/PBR | <input type="checkbox"/> | <input type="checkbox"/> | NFR | | <input type="checkbox"/> | <input type="checkbox"/> | <input type="checkbox"/> | | 57.0# | 933 | | | | | | | | |
| Two-Tone, Upholstered Seat | L2DTB/PBR | <input type="checkbox"/> | <input type="checkbox"/> | NFR | | <input type="checkbox"/> | <input type="checkbox"/> | <input type="checkbox"/> | <input type="checkbox"/> | 57.0# | N/A | 1070 | 1077 | 1099 | 1109 | 1155 | 1172 | 1195 | 1228 |
| | | | | | | | | | | | | | | | | | | | |
| | | | | | | | | | | | | | | | | | | | |
| | | | | | | | | | | | | | | | | | | | |
| | | | | | | | | | | | | | | | | | | | |
| | | | | | | | | | | | | | | | | | | | |
| | | | | | | | | | | | | | | | | | | | |
| | | | | | | | | | | | | | | | | | | | |
| | | | | | | | | | | | | | | | | | | | |



2DWS1
2DWS2
2DWSA
2DWSB

- Poly Bookbag Rack**
- Non-handed worksurface in choice of plastic or laminate
 - Poly bookbag rack included
 - Poly bookbag rack includes two accessory slots and a cupholder
 - Poly Bookbag rack is only available in black
 - Solid or two-tone colored shell
 - Unlimited color match's
 - 17 degrees of hip articulation

HOW TO ORDER

- Indicate the following information on order form:
1. Quantity of each item.
 2. Model number, including options. See "How To Build a Model Number".
 3. Any special service required.

Note: • The indicates that a choice is required.
• The absence of the indicates that no choice is required.
• Alpha-numeric characters in place of indicate that no other alternatives are available.

HOW TO BUILD A MODEL NUMBER

- A** Select basic model.
- B** Select worksurface type.
LW - Laminate worksurface; add \$60
PW - Plastic worksurface
- C** Select frame color.
 Refer to the **Product Color Options** page in this price list.
- D** Select fire code.
NFR - Compliance to TB 117-2013
FR - Compliance to TB 133
- E** Select solid poly color.
 Refer to the **Product Color Options** page in this price list.
- F** Select outside/inside poly color.
 Refer to the **Product Color Options** page in this price list.
- G** Select surface finish.

Refer to the **Product Color Options** page in this price list.

- H** Select caster/glide option.
C - Carpet casters
S - Hard floor casters
GL - Glides
SCG - Front hard floor casters, rear glides
CCG - Front carpet casters, rear glides
- I** Select upholstery grade/color.
 Refer to ki.com/fabrics

UPHOLSTERY INFORMATION

C.O.M. Upholstery
 C.O.M. requirement for 10 chairs or less with upholstered seat or upholstered seat and back is 3/4 yard per chair of 54" wide nondirectional fabric. For orders of 11 or more with upholstered seat and back and for complete information on ordering C.O.M. see "Ordering C.O.M., C.O.V. and C.O.L." section.

California TB133 Fire Safety Code
 For California Technical Bulletin 133 compliant models, add the following upcharge:
 Model=Solid Color, Polypropylene
 Added List Price=\$13
 Model=Solid Color, Upholstered Seat
 Added List Price=\$81

FINISH INFORMATION

Poly Bookbag Rack comes standard in Black. Other KI standard poly colors are available through a Product Modification Request. No upcharge or fees apply for orders of 20 or more. A net setup fee applies for orders of 19 or less. Please allow up 1 week additional leadtime.

SPECIAL SERVICES

Special Carton Marking

With specially marked information N/C

Shipping
 Ships assembled, FOB Green Bay, WI 54302, freight excluded. Freight class 300.

Specifications and prices are subject to change without prior notice.

Learn2® Classroom Furniture (Freight Excluded)

Doni® Seating with Worksurface



Learn2® Classroom Furniture (Freight Excluded)

Doni® Seating with Worksurface

| Features | MODEL NUMBER | | | | | | | | | Approx. Packaged Weight | Freight Excluded Pricing Unupholstered | Freight Excluded Pricing Fabric Grade 1, C.O.M. & COV | Freight Excluded Pricing Fabric Grade 2 | Freight Excluded Pricing Fabric Grade 3 & Group 2V Vinyl | Freight Excluded Pricing Pallas Fabric Group P0 | Freight Excluded Pricing Pallas Fabric Group P1 | Freight Excluded Pricing Pallas Fabric Group P2 | Freight Excluded Pricing Pallas Fabric Group P3 | Freight Excluded Pricing Pallas Fabric Group P4 |
|-------------------------------|--------------|--------------------------|--------------------------|--------------------------|--------------------------|---------------------------|------------------------------|--------------------------|--------------------------|-------------------------|----------------------------------------|-------------------------------------------------------|-----------------------------------------|----------------------------------------------------------|-------------------------------------------------|-------------------------------------------------|-------------------------------------------------|-------------------------------------------------|-------------------------------------------------|
| | Basic Model | Surface Type | Frame Color | Fire Code | Poly Solid Color | Poly Outside/Inside Color | Surface Finish/Plastic Color | Glide Option | Uph. Color | | | | | | | | | | |
| Solid Color, Polypropylene | L2DT1/FBR | <input type="checkbox"/> | <input type="checkbox"/> | <input type="checkbox"/> | <input type="checkbox"/> | | <input type="checkbox"/> | <input type="checkbox"/> | | 57.0# | \$ 890 | | | | | | | | |
| Solid Color, Upholstered Seat | L2DT2/FBR | <input type="checkbox"/> | <input type="checkbox"/> | <input type="checkbox"/> | <input type="checkbox"/> | | <input type="checkbox"/> | <input type="checkbox"/> | <input type="checkbox"/> | 57.0# | N/A | 1025 | 1037 | 1055 | 1064 | 1112 | 1129 | 1153 | 1187 |
| Two-Tone, Polypropylene | L2DTA/FBR | <input type="checkbox"/> | <input type="checkbox"/> | NFR | | <input type="checkbox"/> | <input type="checkbox"/> | <input type="checkbox"/> | | 57.0# | 953 | | | | | | | | |
| Two-Tone, Upholstered Seat | L2DTB/FBR | <input type="checkbox"/> | <input type="checkbox"/> | NFR | | <input type="checkbox"/> | <input type="checkbox"/> | <input type="checkbox"/> | <input type="checkbox"/> | 57.0# | N/A | 1088 | 1101 | 1119 | 1129 | 1176 | 1195 | 1217 | 1249 |
| | | | | | | | | | | | | | | | | | | | |
| | | | | | | | | | | | | | | | | | | | |
| | | | | | | | | | | | | | | | | | | | |
| | | | | | | | | | | | | | | | | | | | |
| | | | | | | | | | | | | | | | | | | | |
| | | | | | | | | | | | | | | | | | | | |
| | | | | | | | | | | | | | | | | | | | |
| | | | | | | | | | | | | | | | | | | | |
| | | | | | | | | | | | | | | | | | | | |
| | | | | | | | | | | | | | | | | | | | |
| | | | | | | | | | | | | | | | | | | | |
| | | | | | | | | | | | | | | | | | | | |
| | | | | | | | | | | | | | | | | | | | |



- 2DWS1
- 2DWS2
- 2DWSA
- 2DWSB
- Flat Accessory Rack**
- Non-handed worksurface in choice of plastic or laminate
- Flat accessory rack included
- Solid or two-tone colored shell
- Unlimited color match's
- 17 degrees of hip articulation

HOW TO ORDER

- Indicate the following information on order form:
- Quantity of each item.
 - Model number, including options. See "How To Build a Model Number".
 - Any special service required.

Note:

- The indicates that a choice is required.
- The absence of the indicates that no choice is required.
- Alpha-numeric characters in place of indicate that no other alternatives are available.

HOW TO BUILD A MODEL NUMBER

- A** Select basic model.
- B** Select worksurface type.

| | |
|-----------|----------------------------------|
| LW | - Laminate worksurface; add \$60 |
| PW | - Plastic worksurface |
- C** Select frame color.
Refer to the **Product Color Options** page in this price list.
- D** Select fire code.

| | |
|------------|-----------------------------|
| NFR | - Compliance to TB 117-2013 |
| FR | - Compliance to TB 133 |
- E** Select solid poly color.
Refer to the **Product Color Options** page in this price list.
- F** Select outside/inside poly color.
Refer to the **Product Color Options** page in this price list.
- G** Select surface finish.

Refer to the **Product Color Options** page in this price list.

- H** Select caster/glide option.

| | |
|------------|-----------------------------------------|
| C | - Carpet casters |
| S | - Hard floor casters |
| GL | - Glides |
| SCG | - Front hard floor casters, rear glides |
| CCG | - Front carpet casters, rear glides |

- I** Select upholstery grade/color.
Refer to ki.com/fabrics

UPHOLSTERY INFORMATION

C.O.M. Upholstery
C.O.M. requirement for 10 chairs or less with upholstered seat or upholstered seat and back is 3/4 yard per chair of 54" wide nondirectional fabric. For orders of 11 or more with upholstered seat and back and for complete information on ordering C.O.M. see "Ordering C.O.M., C.O.V. and C.O.L." section.

California TB133 Fire Safety Code
For California Technical Bulletin 133 compliant models, add the following upcharge:
 Model=Solid Color, Polypropylene
 Added List Price=\$13
 Model=Solid Color, Upholstered Seat
 Added List Price=\$81

SPECIAL SERVICES

Special Carton Marking
With specially marked information N/C

Shipping
Ships assembled, FOB Green Bay, WI 54302, freight excluded. Freight class 300.

Specifications and prices are subject to change without prior notice.



Learn2® Classroom Furniture (Freight Excluded)

Intellect Wave® Seating with Worksurface



Learn2® Classroom Furniture (Freight Excluded)

Intellect Wave® Seating with Worksurface

| MODEL | Features | MODEL NUMBER | | | | | | | | Approx. Packaged Weight | Freight Excluded Pricing | Freight Excluded Pricing Fabric Grade 1, C.O.M. & COV | Freight Excluded Pricing Fabric Grade 2 | Freight Excluded Pricing Fabric Grade 3 & Group 2V Vinyl | Freight Excluded Pricing Pallas Fabric Group P0 | Freight Excluded Pricing Pallas Fabric Group P1 | Freight Excluded Pricing Pallas Fabric Group P2 | Freight Excluded Pricing Pallas Fabric Group P3 | Freight Excluded Pricing Pallas Fabric Group P4 |
|--------------------------------------------------------------------------------------------------------------------------------------------------------------------------------------------------------------------------------------------|------------------|--------------|--------------------------|--------------------------|--------------------------|--------------------------|------------------------------|--------------------------|--------------------------|-------------------------|--------------------------|-------------------------------------------------------|-----------------------------------------|----------------------------------------------------------|-------------------------------------------------|-------------------------------------------------|-------------------------------------------------|-------------------------------------------------|-------------------------------------------------|
| | | Basic Model | Surface Type | Frame Color | Fire Code | Shell Color | Surface Finish/Plastic Color | Glide Option | Uph. Color | | | | | | | | | | |
|  Without Accessory Rack • Non-handed worksurface in choice of plastic or laminate | Polypropylene | L2WTP/NAR | <input type="checkbox"/> | <input type="checkbox"/> | <input type="checkbox"/> | <input type="checkbox"/> | <input type="checkbox"/> | <input type="checkbox"/> | <input type="checkbox"/> | 37.0# | \$ 669 | | | | | | | | |
| | Upholstered Seat | L2WTUS/NAR | <input type="checkbox"/> | <input type="checkbox"/> | <input type="checkbox"/> | <input type="checkbox"/> | <input type="checkbox"/> | <input type="checkbox"/> | <input type="checkbox"/> | 40.0# | N/A | 734 | 739 | 751 | 739 | 786 | 801 | 822 | 838 |
| 2WWSP 2WWSU | | | | | | | | | | | | | | | | | | | |
|  Accessory Rack • Non-handed worksurface in choice of plastic or laminate • Accessory rack included on both sides of frame | Polypropylene | L2WTP/SAR | <input type="checkbox"/> | <input type="checkbox"/> | <input type="checkbox"/> | <input type="checkbox"/> | <input type="checkbox"/> | <input type="checkbox"/> | <input type="checkbox"/> | 46.0# | \$ 694 | | | | | | | | |
| | Upholstered Seat | L2WTUS/SAR | <input type="checkbox"/> | <input type="checkbox"/> | <input type="checkbox"/> | <input type="checkbox"/> | <input type="checkbox"/> | <input type="checkbox"/> | <input type="checkbox"/> | 49.0# | N/A | 761 | 765 | 777 | 765 | 813 | 828 | 850 | 863 |
| 2WWSP 2WWSU | | | | | | | | | | | | | | | | | | | |
|  Cup Holder/Accessory Rack • Non-handed worksurface in choice of plastic or laminate • Cup holder/accessory rack included on both sides of frame | Polypropylene | L2WTP/CAR | <input type="checkbox"/> | <input type="checkbox"/> | <input type="checkbox"/> | <input type="checkbox"/> | <input type="checkbox"/> | <input type="checkbox"/> | <input type="checkbox"/> | 46.0# | \$ 738 | | | | | | | | |
| | Upholstered Seat | L2WTUS/CAR | <input type="checkbox"/> | <input type="checkbox"/> | <input type="checkbox"/> | <input type="checkbox"/> | <input type="checkbox"/> | <input type="checkbox"/> | <input type="checkbox"/> | 49.0# | N/A | 804 | 808 | 821 | 808 | 856 | 871 | 891 | 906 |
| 2WWSP 2WWSU | | | | | | | | | | | | | | | | | | | |

A **B** **C** **D** **E** **F** **G** **H**

HOW TO ORDER

- Indicate the following information on order form:
- Quantity of each item.
 - Model number, including options. See "How To Build a Model Number".
 - Any special service required.

Note: • The indicates that a choice is required.
 • The absence of the indicates that no choice is required.
 • Alpha-numeric characters in place of indicate that no other alternatives are available.

HOW TO BUILD A MODEL NUMBER

- A** Select basic model.
- B** Select worksurface type.
 - LW** - Laminate worksurface; add \$60
 - PW** - Plastic worksurface
- C** Select frame color. Refer to the **Product Color Options** page in this price list.
- D** Select fire code.
 - NFR** - Compliance to TB 117-2013
 - FR** - Compliance to TB 133
 See Upholstery Information for TB133 upcharge.
- E** Select shell color. Refer to the **Product Color Options** page in this price list.
- F** Select surface finish. Refer to the **Product Color Options** page in this price list.
- G** Select caster/glide option.
 - C** - Carpet casters
 - S** - Hard floor casters
 - GL** - Glides
 - SCG** - Front hard floor casters, rear glides
 - CCG** - Front carpet casters, rear glides
- H** Select upholstery grade/color. Refer to ki.com/fabrics

UPHOLSTERY INFORMATION

C.O.M. Upholstery
 C.O.M. requirement is 5/8 yard per chair for seat of 54" wide nondirectional fabric. For complete information on ordering C.O.M. see "Ordering C.O.M., C.O.V. and C.O.L." section.

California TB133 Fire Safety Code
 For California Technical Bulletin 133 compliant models, add the following upcharge:
 Model=Polypropylene
 Added List Price=\$26
 Model=Upholstered Seat
 Added List Price=\$76

SPECIAL SERVICES

Special Carton Marking
 With specially marked information N/C

Shipping
 Ships assembled, FOB Green Bay, WI 54302, freight excluded. Freight class 300.

Specifications and prices are subject to change without prior notice.



Learn2® Classroom Furniture (Freight Excluded)

Intellect Wave® Seating with Worksurface



Learn2® Classroom Furniture (Freight Excluded)

Intellect Wave® Seating with Worksurface

| MODEL | Features | MODEL NUMBER | | | | | | | | Approx. Packaged Weight | Freight Excluded Pricing | Freight Excluded Pricing Fabric Grade 1, C.O.M. & COV | Freight Excluded Pricing Fabric Grade 2 | Freight Excluded Pricing Fabric Grade 3 & Group 2V Vinyl | Freight Excluded Pricing Pallas Fabric Group P0 | Freight Excluded Pricing Pallas Fabric Group P1 | Freight Excluded Pricing Pallas Fabric Group P2 | Freight Excluded Pricing Pallas Fabric Group P3 | Freight Excluded Pricing Pallas Fabric Group P4 |
|----------------------------------------------------------------------------------------------------|---------------------------------------------------------------------------------------------------------------------------------------------------------------------------------------------------------------------------------------------|------------------|--------------|--------------------------|--------------------------|--------------------------|------------------------------|--------------------------|--------------------------|--------------------------|--------------------------|-------------------------------------------------------|-----------------------------------------|----------------------------------------------------------|-------------------------------------------------|-------------------------------------------------|-------------------------------------------------|-------------------------------------------------|-------------------------------------------------|
| | | Basic Model | Surface Type | Frame Color | Fire Code | Shell Color | Surface Finish/Plastic Color | Glide Option | Uph. Color | | | | | | | | | | |
|  2WWSP 2WWSU | Poly Bookbag Rack • Non-handed worksurface in choice of plastic or laminate • Poly bookbag rack included • Poly bookbag rack includes two accessory slots and a cupholder • Poly Bookbag rack is only available in black | Polypropylene | L2WTP/PBR | <input type="checkbox"/> | <input type="checkbox"/> | <input type="checkbox"/> | <input type="checkbox"/> | <input type="checkbox"/> | <input type="checkbox"/> | 46.0# | \$ 717 | | | | | | | | |
| | | Upholstered Seat | L2WTUS/PBR | <input type="checkbox"/> | <input type="checkbox"/> | <input type="checkbox"/> | <input type="checkbox"/> | <input type="checkbox"/> | <input type="checkbox"/> | <input type="checkbox"/> | 49.0# | N/A | 782 | 789 | 800 | 789 | 835 | 851 | 871 |
|  2WWSP 2WWSU | Flat Accessory Rack • Non-handed worksurface in choice of plastic or laminate • Flat accessory rack included | Polypropylene | L2WTP/FBR | <input type="checkbox"/> | <input type="checkbox"/> | <input type="checkbox"/> | <input type="checkbox"/> | <input type="checkbox"/> | <input type="checkbox"/> | 46.0# | \$ 738 | | | | | | | | |
| | | Upholstered Seat | L2WTUS/FBR | <input type="checkbox"/> | <input type="checkbox"/> | <input type="checkbox"/> | <input type="checkbox"/> | <input type="checkbox"/> | <input type="checkbox"/> | <input type="checkbox"/> | 49.0# | N/A | 804 | 808 | 821 | 808 | 856 | 871 | 891 |

A **B** **C** **D** **E** **F** **G** **H**

HOW TO ORDER

- Indicate the following information on order form:
- Quantity of each item.
 - Model number, including options. See "How To Build a Model Number".
 - Any special service required.

Note: • The indicates that a choice is required.
 • The absence of the indicates that no choice is required.
 • Alpha-numeric characters in place of indicate that no other alternatives are available.

HOW TO BUILD A MODEL NUMBER

- A** Select basic model.
- B** Select worksurface type.
 LW - Laminate worksurface; add \$60
 PW - Plastic worksurface
- C** Select frame color.
 Refer to the **Product Color Options** page in this price list.
- D** Select fire code.
 FR - Compliance to TB 133
 NFR - Compliance to TB 117-2013
 See Upholstery Information for TB133 upcharge.
- E** Select shell color.
 Refer to the **Product Color Options** page in this price list.
- F** Select surface finish.
 Refer to the **Product Color Options** page in this price list.

- G** Select caster/glide option.
 C - Carpet casters
 S - Hard floor casters
 GL - Glides
 SCG - Front hard floor casters, rear glides
 CCG - Front carpet casters, rear glides
- H** Select upholstery grade/color.
 Refer to ki.com/fabrics

UPHOLSTERY INFORMATION

C.O.M. Upholstery
 C.O.M. requirement is 5/8 yard per chair for seat of 54" wide nondirectional fabric. For complete information on ordering C.O.M. see "Ordering C.O.M., C.O.V. and C.O.L." section.

California TB133 Fire Safety Code
 For California Technical Bulletin 133 compliant models, add the following upcharge:
 Model=Polypropylene
 Added List Price=\$26
 Model=Upholstered Seat
 Added List Price=\$76

FINISH INFORMATION

Poly Bookbag Rack comes standard in Black. Other KI standard poly colors are available through a Product Modification Request. No upcharge or fees apply for orders of 20 or more. A net setup fee applies for orders of 19 or less. Please allow up 1 week additional leadtime.

SPECIAL SERVICES

Special Carton Marking
 With specially marked information N/C

Shipping
 Ships assembled, FOB Green Bay, WI 54302, freight excluded. Freight class 300.

Specifications and prices are subject to change without prior notice.



Learn2® Classroom Furniture (Freight Excluded)

LimeLite™ Seating with Worksurface



Learn2® Classroom Furniture (Freight Excluded)

LimeLite™ Seating with Worksurface

| MODEL | Features | MODEL NUMBER | | | | | | | | Approx. Packaged Weight | Freight Excluded Pricing | Freight Excluded Pricing Fabric Grade 1, C.O.M. & COV | Freight Excluded Pricing Fabric Grade 2 | Freight Excluded Pricing Fabric Grade 3 & Group 2V Vinyl | Freight Excluded Pricing Pallas Fabric Group P0 | Freight Excluded Pricing Pallas Fabric Group P1 | Freight Excluded Pricing Pallas Fabric Group P2 | Freight Excluded Pricing Pallas Fabric Group P3 | Freight Excluded Pricing Pallas Fabric Group P4 |
|---------------------------------------------------------------------------------------------------------------------------------------------------------------------------------------------------------------------------------------------------------------------------------------|------------------|--------------|--------------------------|--------------------------|--------------------------|--------------------------|------------------------------|--------------------------|--------------------------|-------------------------|--------------------------|-------------------------------------------------------|-----------------------------------------|----------------------------------------------------------|-------------------------------------------------|-------------------------------------------------|-------------------------------------------------|-------------------------------------------------|-------------------------------------------------|
| | | Basic Model | Surface Type | Frame Color | Fire Code | Shell Color | Surface Finish/Plastic Color | Glide Option | Up. Color | | | | | | | | | | |
|  Without Accessory Rack • One-piece shell • Passive back flex • Non-handed worksurface in choice of plastic or laminate | Polypropylene | L2LT1/NA/NAR | <input type="checkbox"/> | <input type="checkbox"/> | <input type="checkbox"/> | <input type="checkbox"/> | <input type="checkbox"/> | <input type="checkbox"/> | <input type="checkbox"/> | 47.0# | \$ 799 | | | | | | | | |
| | Upholstered Seat | L2LT2/NA/NAR | <input type="checkbox"/> | <input type="checkbox"/> | <input type="checkbox"/> | <input type="checkbox"/> | <input type="checkbox"/> | <input type="checkbox"/> | <input type="checkbox"/> | 49.0# | N/A | 868 | 899 | 915 | 907 | 955 | 977 | 1001 | 1021 |
| 2LWS1 2LWS2 | | | | | | | | | | | | | | | | | | | |
|  Accessory Rack • One-piece shell • Passive back flex • Non-handed worksurface in choice of plastic or laminate • Accessory rack included on both sides of frame | Polypropylene | L2LT1/NA/SAR | <input type="checkbox"/> | <input type="checkbox"/> | <input type="checkbox"/> | <input type="checkbox"/> | <input type="checkbox"/> | <input type="checkbox"/> | <input type="checkbox"/> | 55.0# | \$ 827 | | | | | | | | |
| | Upholstered Seat | L2LT2/NA/SAR | <input type="checkbox"/> | <input type="checkbox"/> | <input type="checkbox"/> | <input type="checkbox"/> | <input type="checkbox"/> | <input type="checkbox"/> | <input type="checkbox"/> | 57.0# | N/A | 895 | 926 | 942 | 934 | 982 | 1004 | 1028 | 1048 |
| 2LWS1 2LWS2 | | | | | | | | | | | | | | | | | | | |
|  Cup Holder/Accessory Rack • One-piece shell • Passive back flex • Non-handed worksurface in choice of plastic or laminate • Cup holder/accessory rack included on both sides of frame | Polypropylene | L2LT1/NA/CAR | <input type="checkbox"/> | <input type="checkbox"/> | <input type="checkbox"/> | <input type="checkbox"/> | <input type="checkbox"/> | <input type="checkbox"/> | <input type="checkbox"/> | 55.0# | \$ 869 | | | | | | | | |
| | Upholstered Seat | L2LT2/NA/CAR | <input type="checkbox"/> | <input type="checkbox"/> | <input type="checkbox"/> | <input type="checkbox"/> | <input type="checkbox"/> | <input type="checkbox"/> | <input type="checkbox"/> | 57.0# | N/A | 938 | 969 | 985 | 977 | 1025 | 1047 | 1071 | 1091 |
| 2LWS1 2LWS2 | | | | | | | | | | | | | | | | | | | |

A **B** **C** **D** **E** **F** **G** **H**

HOW TO ORDER

- Indicate the following information on order form:
- Quantity of each item.
 - Model number, including options. See "How To Build a Model Number".
 - Any special service required.

Note: • The indicates that a choice is required.
 • The absence of the indicates that no choice is required.
 • Alpha-numeric characters in place of indicate that no other alternatives are available.

HOW TO BUILD A MODEL NUMBER

- A** Select basic model.
- B** Select worksurface type.
 LW - Laminate worksurface
 PW - Plastic worksurface
- C** Select frame color.
 Refer to the **Product Color Options** page in this price list.
- D** Select fire code.
 NFR - Compliance to TB 117-2013
 FR - Compliance to TB 133
 See Upholstery Information for TB133 upcharge.
- E** Select poly seat and back color.
 Refer to the **Product Color Options** page in this price list.
- F** Select surface finish.
 Refer to the **Product Color Options** page in this price list.

- G** Select caster/glide option.
 C - Carpet casters
 S - Hard floor casters
 GL - Glides
 SCG - Front hard floor casters, rear glides
 CCG - Front carpet casters, rear glides
- H** Select upholstery grade/color.
 Refer to ki.com/fabrics

UPHOLSTERY INFORMATION

C.O.M. Upholstery
 C.O.M. requirement for 10 chairs or less with upholstered seat or upholstered seat and back is 3/4 yard per chair of 54" wide nondirectional fabric. For orders of 11 or more with upholstered seat and back and for complete information on ordering C.O.M. see "Ordering C.O.M., C.O.V. and C.O.L." section.

California TB133 Fire Safety Code
 For California Technical Bulletin 133 compliant models, add the following upcharge:
 Model=Polypropylene
 Added List Price=\$13
 Model=Upholstered Seat
 Added List Price=\$78



SPECIAL SERVICES

Special Carton Marking
 With specially marked information N/C

Shipping
 Ships assembled, FOB Green Bay, WI 54302, freight excluded. Freight class 300.

Specifications and prices are subject to change without prior notice.



| MODEL | Features | MODEL NUMBER | | | | | | | | Approx. Packaged Weight | Freight Excluded Pricing | Freight Excluded Pricing Fabric Grade 1, C.O.M. & COV | Freight Excluded Pricing Fabric Grade 2 | Freight Excluded Pricing Fabric Grade 3 & Group 2V Vinyl | Freight Excluded Pricing Pallas Fabric Group P0 | Freight Excluded Pricing Pallas Fabric Group P1 | Freight Excluded Pricing Pallas Fabric Group P2 | Freight Excluded Pricing Pallas Fabric Group P3 | Freight Excluded Pricing Pallas Fabric Group P4 | |
|-----------------------------------------------------------------------------------------------------|-----------------------------------------------------------------------------------------------------------------------------------------------------------------------------------------------------------------------------------------------------------------------------------------|------------------|--------------|--------------------------|--------------------------|--------------------------|------------------------------|--------------------------|--------------------------|--------------------------|--------------------------|-------------------------------------------------------|-----------------------------------------|----------------------------------------------------------|-------------------------------------------------|-------------------------------------------------|-------------------------------------------------|-------------------------------------------------|-------------------------------------------------|------|
| | | Basic Model | Surface Type | Frame Color | Fire Code | Shell Color | Surface Finish/Plastic Color | Glide Option | Uph. Color | | | | | | | | | | | |
|  2LWS1 2LWS2 | Poly Bookbag Rack • One-piece shell • Passive back flex • Non-handed worksurface in choice of plastic or laminate • Poly bookbag rack included • Poly bookbag rack includes two accessory slots and a cupholder • Poly Bookbag rack is only available in black | Polypropylene | L2LT1/NA/PBR | <input type="checkbox"/> | <input type="checkbox"/> | <input type="checkbox"/> | <input type="checkbox"/> | <input type="checkbox"/> | <input type="checkbox"/> | <input type="checkbox"/> | 51.0# | \$ 848 | | | | | | | | |
| | | Upholstered Seat | L2LT2/NA/PBR | <input type="checkbox"/> | <input type="checkbox"/> | <input type="checkbox"/> | <input type="checkbox"/> | <input type="checkbox"/> | <input type="checkbox"/> | <input type="checkbox"/> | <input type="checkbox"/> | 53.0# | N/A | 917 | 948 | 964 | 956 | 1004 | 1026 | 1050 |
|  2LWS1 2LWS2 | Flat Accessory Rack • One-piece shell • Passive back flex • Non-handed worksurface in choice of plastic or laminate • Flat accessory rack included | Polypropylene | L2LT1/NA/FBR | <input type="checkbox"/> | <input type="checkbox"/> | <input type="checkbox"/> | <input type="checkbox"/> | <input type="checkbox"/> | <input type="checkbox"/> | <input type="checkbox"/> | 57.0# | \$ 869 | | | | | | | | |
| | | Upholstered Seat | L2LT2/NA/FBR | <input type="checkbox"/> | <input type="checkbox"/> | <input type="checkbox"/> | <input type="checkbox"/> | <input type="checkbox"/> | <input type="checkbox"/> | <input type="checkbox"/> | <input type="checkbox"/> | 59.0# | N/A | 938 | 969 | 985 | 977 | 1025 | 1047 | 1071 |

A **B** **C** **D** **E** **F** **G** **H**

HOW TO ORDER

- Indicate the following information on order form:
- Quantity of each item.
 - Model number, including options. See "How To Build a Model Number".
 - Any special service required.

Note: • The indicates that a choice is required.
 • The absence of the indicates that no choice is required.
 • Alpha-numeric characters in place of indicate that no other alternatives are available.

HOW TO BUILD A MODEL NUMBER

- A** Select basic model.
- B** Select worksurface type.
 LW - Laminate worksurface
 PW - Plastic worksurface
- C** Select frame color. Refer to the **Product Color Options** page in this price list.
- D** Select fire code.
 NFR - Compliance to TB 117-2013
 FR - Compliance to TB 133
 See Upholstery Information for TB133 upcharge.
- E** Select poly seat and back color. Refer to the **Product Color Options** page in this price list.
- F** Select surface finish. Refer to the **Product Color Options** page in this price list.

- G** Select caster/glide option.
 C - Carpet casters
 S - Hard floor casters
 GL - Glides
 SCG - Front hard floor casters, rear glides
 CCG - Front carpet casters, rear glides
- H** Select upholstery grade/color. Refer to ki.com/fabrics

UPHOLSTERY INFORMATION

C.O.M. Upholstery
 C.O.M. requirement for 10 chairs or less with upholstered seat or upholstered seat and back is 3/4 yard per chair of 54" wide nondirectional fabric. For orders of 11 or more with upholstered seat and back and for complete information on ordering C.O.M. see "Ordering C.O.M., C.O.V. and C.O.L." section.

California TB133 Fire Safety Code
 For California Technical Bulletin 133 compliant models, add the following upcharge:
 Model=Polypropylene
 Added List Price=\$13
 Model=Upholstered Seat
 Added List Price=\$78

FINISH INFORMATION

Poly Bookbag Rack comes standard in Black. Other KI standard poly colors are available through a Product Modification Request. No upcharge or fees apply for orders of 20 or more. A net setup fee applies for orders of 19 or less. Please allow up 1 week additional leadtime.

SPECIAL SERVICES

Special Carton Marking

With specially marked information N/C

Shipping
 Ships assembled, FOB Green Bay, WI 54302, freight excluded. Freight class 300.

Specifications and prices are subject to change without prior notice.



Learn2® Classroom Furniture (Freight Excluded)

Strive® Seating with Worksurface



Learn2® Classroom Furniture (Freight Excluded)

Strive® Seating with Worksurface

| MODEL | Features | MODEL NUMBER | | | | | | | | | Approx. Packaged Weight | Freight Excluded Pricing | Freight Excluded Pricing Fabric Grade 1, C.O.M. & COV | Freight Excluded Pricing Fabric Grade 2 | Freight Excluded Pricing Fabric Grade 3 & Group 2V Vinyl | Freight Excluded Pricing Pallas Fabric Group P0 | Freight Excluded Pricing Pallas Fabric Group P1 | Freight Excluded Pricing Pallas Fabric Group P2 | Freight Excluded Pricing Pallas Fabric Group P3 | Freight Excluded Pricing Pallas Fabric Group P4 |
|--------------------------------------------------------------------------------------------------------------------------------------------------------------------------------------------------------------------------------------------|------------------|---------------|--------------------------|--------------------------|--------------------------|--------------------------|------------------------------|--------------------------|--------------------------|--------------------------|-------------------------|--------------------------|-------------------------------------------------------|-----------------------------------------|----------------------------------------------------------|-------------------------------------------------|-------------------------------------------------|-------------------------------------------------|-------------------------------------------------|-------------------------------------------------|
| | | Basic Model | Surface Type | Frame Color | Fire Code | Shell Color | Surface Finish/Plastic Color | Glide Option | Uph. Color | | | | | | | | | | | |
|  Without Accessory Rack • Non-handed worksurface in choice of plastic or laminate | Polypropylene | L2STP/NA/NAR | <input type="checkbox"/> | <input type="checkbox"/> | <input type="checkbox"/> | <input type="checkbox"/> | <input type="checkbox"/> | <input type="checkbox"/> | <input type="checkbox"/> | <input type="checkbox"/> | 48.0# | \$ 793 | | | | | | | | |
| | Upholstered Seat | L2STUS/NA/NAR | <input type="checkbox"/> | <input type="checkbox"/> | <input type="checkbox"/> | <input type="checkbox"/> | <input type="checkbox"/> | <input type="checkbox"/> | <input type="checkbox"/> | <input type="checkbox"/> | 51.0# | N/A | 862 | 895 | 908 | 902 | 949 | 973 | 995 | 1014 |
| 2SWSP 2SWSU | | | | | | | | | | | | | | | | | | | | |
|  Accessory Rack • Non-handed worksurface in choice of plastic or laminate • Accessory rack included on both sides of frame | Polypropylene | L2STP/NA/SAR | <input type="checkbox"/> | <input type="checkbox"/> | <input type="checkbox"/> | <input type="checkbox"/> | <input type="checkbox"/> | <input type="checkbox"/> | <input type="checkbox"/> | <input type="checkbox"/> | 57.0# | \$ 821 | | | | | | | | |
| | Upholstered Seat | L2STUS/NA/SAR | <input type="checkbox"/> | <input type="checkbox"/> | <input type="checkbox"/> | <input type="checkbox"/> | <input type="checkbox"/> | <input type="checkbox"/> | <input type="checkbox"/> | <input type="checkbox"/> | 60.0# | N/A | 889 | 921 | 934 | 930 | 975 | 996 | 1021 | 1042 |
| 2SWSP 2SWSU | | | | | | | | | | | | | | | | | | | | |
|  Cup Holder/Accessory Rack • Non-handed worksurface in choice of plastic or laminate • Cup holder/accessory rack included on both sides of frame | Polypropylene | L2STP/NA/CAR | <input type="checkbox"/> | <input type="checkbox"/> | <input type="checkbox"/> | <input type="checkbox"/> | <input type="checkbox"/> | <input type="checkbox"/> | <input type="checkbox"/> | <input type="checkbox"/> | 57.0# | \$ 863 | | | | | | | | |
| | Upholstered Seat | L2STUS/NA/CAR | <input type="checkbox"/> | <input type="checkbox"/> | <input type="checkbox"/> | <input type="checkbox"/> | <input type="checkbox"/> | <input type="checkbox"/> | <input type="checkbox"/> | <input type="checkbox"/> | 60.0# | N/A | 932 | 964 | 979 | 974 | 1020 | 1042 | 1064 | 1085 |
| 2SWSP 2SWSU | | | | | | | | | | | | | | | | | | | | |

A **B** **C** **D** **E** **F** **G** **H**

HOW TO ORDER

- Indicate the following information on order form:
- Quantity of each item.
 - Model number, including options. See "How To Build a Model Number".
 - Any special service required.

Note: • The indicates that a choice is required.
 • The absence of the indicates that no choice is required.
 • Alpha-numeric characters in place of indicate that no other alternatives are available.

HOW TO BUILD A MODEL NUMBER

- A** Select basic model.
- B** Select worksurface type.
 LW - Laminate worksurface; add \$60
 PW - Plastic worksurface
- C** Select frame color.
 Refer to the **Product Color Options** page in this price list.
- D** Select fire code.
 FR - Compliance to TB 133
 NFR - Compliance to TB 117-2013
 See Upholstery Information for TB133 upcharge.
- E** Select poly seat and back color.
 Refer to the **Product Color Options** page in this price list.
- F** Select surface finish.
 Refer to the **Product Color Options** page in this price list.

- G** Select caster/glide option.
 C - Carpet casters
 S - Hard floor casters
 GL - Glides
 SCG - Front hard floor casters, rear glides
 CCG - Front carpet casters, rear glides
- H** Select upholstery grade/color.
 Refer to ki.com/fabrics

UPHOLSTERY INFORMATION

C.O.M. Upholstery
 C.O.M. requirement for 10 chairs or less with upholstered seat or upholstered seat and back is 3/4 yard per chair of 54" wide nondirectional fabric. For orders of 11 or more with upholstered seat and back and for complete information on ordering C.O.M. see "Ordering C.O.M., C.O.V. and C.O.L." section.

California TB133 Fire Safety Code
 For California Technical Bulletin 133 compliant models, add the following upcharge:
 Model=Polypropylene
 Added List Price=\$13
 Model=Upholstered Seat
 Added List Price=\$78



SPECIAL SERVICES

Special Carton Marking
 With specially marked information N/C

Shipping
 Ships assembled, FOB Green Bay, WI 54302, freight excluded. Freight class 300.

Specifications and prices are subject to change without prior notice.



| MODEL | Features | MODEL NUMBER | | | | | | | | Approx. Packaged Weight | Freight Excluded Pricing | Freight Excluded Pricing Fabric Grade 1, C.O.M. & COV | Freight Excluded Pricing Fabric Grade 2 | Freight Excluded Pricing Fabric Grade 3 & Group 2V Vinyl | Freight Excluded Pricing Pallas Fabric Group P0 | Freight Excluded Pricing Pallas Fabric Group P1 | Freight Excluded Pricing Pallas Fabric Group P2 | Freight Excluded Pricing Pallas Fabric Group P3 | Freight Excluded Pricing Pallas Fabric Group P4 | |
|------------------------------------------------------------------------------------------------------------------------------------------------------------------------------------------------------------------------------------------------------------------------------------------------------------------------------------------------------------------------------------------------------|------------------|---------------|--------------------------|--------------------------|--------------------------|--------------------------|------------------------------|--------------------------|--------------------------|--------------------------|--------------------------|-------------------------------------------------------|-----------------------------------------|----------------------------------------------------------|-------------------------------------------------|-------------------------------------------------|-------------------------------------------------|-------------------------------------------------|-------------------------------------------------|------|
| | | Basic Model | Surface Type | Frame Color | Fire Code | Shell Color | Surface Finish/Plastic Color | Glide Option | Uph. Color | | | | | | | | | | | |
|  <p>Poly Bookbag Rack</p> <ul style="list-style-type: none"> • Non-handed worksurface in choice of plastic or laminate • Poly bookbag rack included • Poly bookbag rack includes two accessory slots and a cupholder • Poly Bookbag rack is only available in black | Polypropylene | L2STP/NA/PBR | <input type="checkbox"/> | <input type="checkbox"/> | <input type="checkbox"/> | <input type="checkbox"/> | <input type="checkbox"/> | <input type="checkbox"/> | <input type="checkbox"/> | 57.0# | \$ 842 | | | | | | | | | |
| | Upholstered Seat | L2STUS/NA/PBR | <input type="checkbox"/> | <input type="checkbox"/> | <input type="checkbox"/> | <input type="checkbox"/> | <input type="checkbox"/> | <input type="checkbox"/> | <input type="checkbox"/> | <input type="checkbox"/> | 60.0# | N/A | 911 | 944 | 958 | 950 | 998 | 1022 | 1044 | 1064 |
| 2SWSP | | | | | | | | | | | | | | | | | | | | |
| 2SWSU | | | | | | | | | | | | | | | | | | | | |
|  <p>Flat Accessory Rack</p> <ul style="list-style-type: none"> • Non-handed worksurface in choice of plastic or laminate • Flat accessory rack included | Polypropylene | L2STP/NA/FBR | <input type="checkbox"/> | <input type="checkbox"/> | <input type="checkbox"/> | <input type="checkbox"/> | <input type="checkbox"/> | <input type="checkbox"/> | <input type="checkbox"/> | 57.0# | \$ 863 | | | | | | | | | |
| | Upholstered Seat | L2STUS/NA/FBR | <input type="checkbox"/> | <input type="checkbox"/> | <input type="checkbox"/> | <input type="checkbox"/> | <input type="checkbox"/> | <input type="checkbox"/> | <input type="checkbox"/> | <input type="checkbox"/> | 60.0# | N/A | 932 | 964 | 979 | 974 | 1020 | 1042 | 1064 | 1085 |
| 2SWSP | | | | | | | | | | | | | | | | | | | | |
| 2SWSU | | | | | | | | | | | | | | | | | | | | |

A B C D E F G H

HOW TO ORDER

- Indicate the following information on order form:
- Quantity of each item.
 - Model number, including options. See "How To Build a Model Number".
 - Any special service required.

Note:

- The indicates that a choice is required.
- The absence of the indicates that no choice is required.
- Alpha-numeric characters in place of indicate that no other alternatives are available.

HOW TO BUILD A MODEL NUMBER

- A** Select basic model.
 - LW** - Laminate worksurface; add \$60
 - PW** - Plastic worksurface
- C** Select frame color. Refer to the **Product Color Options** page in this price list.
- D** Select fire code.
 - FR** - Compliance to TB 133
 - NFR** - Compliance to TB 117-2013
 See Upholstery Information for TB133 upcharge.
- E** Select poly seat and back color. Refer to the **Product Color Options** page in this price list.
- F** Select surface finish. Refer to the **Product Color Options** page in this price list.

- G** Select caster/glide option.
 - C** - Carpet casters
 - S** - Hard floor casters
 - GL** - Glides
 - SCG** - Front hard floor casters, rear glides
 - CCG** - Front carpet casters, rear glides
- H** Select upholstery grade/color. Refer to ki.com/fabrics

UPHOLSTERY INFORMATION

C.O.M. Upholstery
 C.O.M. requirement for 10 chairs or less with upholstered seat or upholstered seat and back is 3/4 yard per chair of 54" wide nondirectional fabric. For orders of 11 or more with upholstered seat and back and for complete information on ordering C.O.M. see "Ordering C.O.M., C.O.V. and C.O.L." section.

California TB133 Fire Safety Code
 For California Technical Bulletin 133 compliant models, add the following upcharge:
 Model=Polypropylene
 Added List Price=\$13
 Model=Upholstered Seat
 Added List Price=\$78

FINISH INFORMATION

Poly Bookbag Rack comes standard in Black. Other KI standard poly colors are available through a Product Modification Request. No upcharge or fees apply for orders of 20 or more. A net setup fee applies for orders of 19 or less. Please allow up 1 week additional leadtime.

SPECIAL SERVICES

Special Carton Marking

With specially marked information N/C

Shipping

Ships assembled, FOB Green Bay, WI 54302, freight excluded. Freight class 300.

Specifications and prices are subject to change without prior notice.



Learn2® Classroom Furniture (Freight Excluded)

Strive® Seating with Worksurface



Learn2® Classroom Furniture (Freight Excluded)

Strive® Seating with Worksurface

| MODEL | Features | MODEL NUMBER | | | | | | | | | Approx. Packaged Weight | Freight Excluded Pricing | Freight Excluded Pricing Fabric Grade 1, C.O.M. & COV | Freight Excluded Pricing Fabric Grade 2 | Freight Excluded Pricing Fabric Grade 3 & Group 2V Vinyl | Freight Excluded Pricing Pallas Fabric Group P0 | Freight Excluded Pricing Pallas Fabric Group P1 | Freight Excluded Pricing Pallas Fabric Group P2 | Freight Excluded Pricing Pallas Fabric Group P3 | Freight Excluded Pricing Pallas Fabric Group P4 |
|-----------------------------------------------------------------------------------------------------|----------------------------------------------------------------------------------------------------------------------------------------------------------------------------|------------------|---------------|--------------------------|--------------------------|--------------------------|------------------------------|--------------------------|--------------------------|--------------------------|--------------------------|--------------------------|-------------------------------------------------------|-----------------------------------------|----------------------------------------------------------|-------------------------------------------------|-------------------------------------------------|-------------------------------------------------|-------------------------------------------------|-------------------------------------------------|
| | | Basic Model | Surface Type | Frame Color | Fire Code | Shell Color | Surface Finish/Plastic Color | Glide Option | Uph. Color | | | | | | | | | | | |
|  2SWSP 2SWSU | Armchair without Accessory Rack • Non-handed worksurface in choice of plastic or laminate | Polypropylene | L2STP/CA/NAR | <input type="checkbox"/> | <input type="checkbox"/> | <input type="checkbox"/> | <input type="checkbox"/> | <input type="checkbox"/> | <input type="checkbox"/> | <input type="checkbox"/> | 51.0# | \$ 860 | | | | | | | | |
| | | Upholstered Seat | L2STUS/CA/NAR | <input type="checkbox"/> | <input type="checkbox"/> | <input type="checkbox"/> | <input type="checkbox"/> | <input type="checkbox"/> | <input type="checkbox"/> | <input type="checkbox"/> | <input type="checkbox"/> | 54.0# | N/A | 930 | 959 | 975 | 969 | 1014 | 1038 | 1060 |
|  2SWSP 2SWSU | Armchair with Accessory Rack • Non-handed worksurface in choice of plastic or laminate • Accessory rack included on both sides of frame | Polypropylene | L2STP/CA/SAR | <input type="checkbox"/> | <input type="checkbox"/> | <input type="checkbox"/> | <input type="checkbox"/> | <input type="checkbox"/> | <input type="checkbox"/> | <input type="checkbox"/> | 60.0# | \$ 886 | | | | | | | | |
| | | Upholstered Seat | L2STUS/CA/SAR | <input type="checkbox"/> | <input type="checkbox"/> | <input type="checkbox"/> | <input type="checkbox"/> | <input type="checkbox"/> | <input type="checkbox"/> | <input type="checkbox"/> | <input type="checkbox"/> | 63.0# | N/A | 954 | 985 | 1000 | 995 | 1042 | 1063 | 1087 |
|  2SWSP 2SWSU | Armchair with Cup Holder/Accessory Rack • Non-handed worksurface in choice of plastic or laminate • Cup holder/accessory rack included on both sides of frame | Polypropylene | L2STP/CA/CAR | <input type="checkbox"/> | <input type="checkbox"/> | <input type="checkbox"/> | <input type="checkbox"/> | <input type="checkbox"/> | <input type="checkbox"/> | <input type="checkbox"/> | 60.0# | \$ 930 | | | | | | | | |
| | | Upholstered Seat | L2STUS/CA/CAR | <input type="checkbox"/> | <input type="checkbox"/> | <input type="checkbox"/> | <input type="checkbox"/> | <input type="checkbox"/> | <input type="checkbox"/> | <input type="checkbox"/> | <input type="checkbox"/> | 63.0# | N/A | 997 | 1028 | 1045 | 1039 | 1085 | 1106 | 1131 |

A B C D E F G H

HOW TO ORDER

- Indicate the following information on order form:
- Quantity of each item.
 - Model number, including options. See "How To Build a Model Number".
 - Any special service required.

Note: • The indicates that a choice is required.
 • The absence of the indicates that no choice is required.
 • Alpha-numeric characters in place of indicate that no other alternatives are available.

HOW TO BUILD A MODEL NUMBER

- A** Select basic model.
- B** Select worksurface type.
 LW - Laminate worksurface; add \$60
 PW - Plastic worksurface
- C** Select frame color.
 Refer to the **Product Color Options** page in this price list.
- D** Select fire code.
 FR - Compliance to TB 133
 NFR - Compliance to TB 117-2013
 See Upholstery Information for TB133 upcharge.
- E** Select poly seat and back color.
 Refer to the **Product Color Options** page in this price list.
- F** Select surface finish.
 Refer to the **Product Color Options** page in this price list.
- G** Select caster/glide option.
 C - Carpet casters
 S - Hard floor casters
 GL - Glides
 SCG - Front hard floor casters, rear glides
 CCG - Front carpet casters, rear glides
- H** Select upholstery grade/color.
 Refer to ki.com/fabrics

UPHOLSTERY INFORMATION

C.O.M. Upholstery
 C.O.M. requirement for 10 chairs or less with upholstered seat or upholstered seat and back is 3/4 yard per chair of 54" wide nondirectional fabric. For orders of 11 or more with upholstered seat and back and for complete information on ordering C.O.M. see "Ordering C.O.M., C.O.V. and C.O.L." section.

California TB133 Fire Safety Code
 For California Technical Bulletin 133 compliant models, add the following upcharge:
 Model=Polypropylene
 Added List Price=\$13
 Model=Upholstered Seat
 Added List Price=\$78

SPECIAL SERVICES

Special Carton Marking
 With specially marked information N/C

Shipping
 Ships assembled, FOB Green Bay, WI 54302, freight excluded. Freight class 300.

Specifications and prices are subject to change without prior notice.



Learn2® Classroom Furniture (Freight Excluded)

Strive® Seating with Worksurface



Learn2® Classroom Furniture (Freight Excluded)

Strive® Seating with Worksurface

| MODEL | Features | MODEL NUMBER | | | | | | | | Approx. Packaged Weight | Freight Excluded Pricing | Freight Excluded Pricing Fabric Grade 1, C.O.M. & COV | Freight Excluded Pricing Fabric Grade 2 | Freight Excluded Pricing Fabric Grade 3 & Group 2V Vinyl | Freight Excluded Pricing Pallas Fabric Group P0 | Freight Excluded Pricing Pallas Fabric Group P1 | Freight Excluded Pricing Pallas Fabric Group P2 | Freight Excluded Pricing Pallas Fabric Group P3 | Freight Excluded Pricing Pallas Fabric Group P4 | |
|--------------------------------------------------------------------------------------------------------------------------------------------------------------------------------------------------------------------------------------------------------------------------------------------------------------------------------------------------------------------------------------------------------------------|------------------|---------------|--------------------------|--------------------------|--------------------------|--------------------------|------------------------------|--------------------------|--------------------------|--------------------------|--------------------------|-------------------------------------------------------|-----------------------------------------|----------------------------------------------------------|-------------------------------------------------|-------------------------------------------------|-------------------------------------------------|-------------------------------------------------|-------------------------------------------------|------|
| | | Basic Model | Surface Type | Frame Color | Fire Code | Shell Color | Surface Finish/Plastic Color | Glide Option | Uph. Color | | | | | | | | | | | |
|  <p>Armchair with Poly Bookbag Rack</p> <ul style="list-style-type: none"> • Non-handed worksurface in choice of plastic or laminate • Poly bookbag rack included • Poly bookbag rack includes two accessory slots and a cupholder • Poly Bookbag rack is only available in black | Polypropylene | L2STP/CA/PBR | <input type="checkbox"/> | <input type="checkbox"/> | <input type="checkbox"/> | <input type="checkbox"/> | <input type="checkbox"/> | <input type="checkbox"/> | <input type="checkbox"/> | 60.0# | \$ 910 | | | | | | | | | |
| | Upholstered Seat | L2STUS/CA/PBR | <input type="checkbox"/> | <input type="checkbox"/> | <input type="checkbox"/> | <input type="checkbox"/> | <input type="checkbox"/> | <input type="checkbox"/> | <input type="checkbox"/> | <input type="checkbox"/> | 63.0# | N/A | 979 | 1008 | 1024 | 1019 | 1064 | 1087 | 1110 | 1130 |
| 2SWSP | | | | | | | | | | | | | | | | | | | | |
| 2SWSU | | | | | | | | | | | | | | | | | | | | |
|  <p>Armchair with Flat Accessory Rack</p> <ul style="list-style-type: none"> • Non-handed worksurface in choice of plastic or laminate • Flat accessory rack included | Polypropylene | L2STP/CA/FBR | <input type="checkbox"/> | <input type="checkbox"/> | <input type="checkbox"/> | <input type="checkbox"/> | <input type="checkbox"/> | <input type="checkbox"/> | <input type="checkbox"/> | 60.0# | \$ 930 | | | | | | | | | |
| | Upholstered Seat | L2STUS/CA/FBR | <input type="checkbox"/> | <input type="checkbox"/> | <input type="checkbox"/> | <input type="checkbox"/> | <input type="checkbox"/> | <input type="checkbox"/> | <input type="checkbox"/> | <input type="checkbox"/> | 63.0# | N/A | 997 | 1028 | 1045 | 1039 | 1085 | 1106 | 1131 | 1151 |
| 2SWSP | | | | | | | | | | | | | | | | | | | | |
| 2SWSU | | | | | | | | | | | | | | | | | | | | |

A B C D E F G H

HOW TO ORDER

- Indicate the following information on order form:
- Quantity of each item.
 - Model number, including options. See "How To Build a Model Number".
 - Any special service required.

Note:

- The indicates that a choice is required.
- The absence of the indicates that no choice is required.
- Alpha-numeric characters in place of indicate that no other alternatives are available.

HOW TO BUILD A MODEL NUMBER

- A** Select basic model.
- B** Select worksurface type.
 - LW** - Laminate worksurface; add \$60
 - PW** - Plastic worksurface
- C** Select frame color. Refer to the **Product Color Options** page in this price list.
- D** Select fire code.
 - FR** - Compliance to TB 133
 - NFR** - Compliance to TB 117-2013
 See Upholstery Information for TB133 upcharge.
- E** Select poly seat and back color. Refer to the **Product Color Options** page in this price list.
- F** Select surface finish. Refer to the **Product Color Options** page in this price list.

- G** Select caster/glide option.
 - C** - Carpet casters
 - S** - Hard floor casters
 - GL** - Glides
 - SCG** - Front hard floor casters, rear glides
 - CCG** - Front carpet casters, rear glides
- H** Select upholstery grade/color. Refer to ki.com/fabrics

UPHOLSTERY INFORMATION

C.O.M. Upholstery
 C.O.M. requirement for 10 chairs or less with upholstered seat or upholstered seat and back is 3/4 yard per chair of 54" wide nondirectional fabric. For orders of 11 or more with upholstered seat and back and for complete information on ordering C.O.M. see "Ordering C.O.M., C.O.V. and C.O.L." section.

California TB133 Fire Safety Code
 For California Technical Bulletin 133 compliant models, add the following upcharge:
 Model=Polypropylene
 Added List Price=\$13
 Model=Upholstered Seat
 Added List Price=\$78

FINISH INFORMATION

Poly Bookbag Rack comes standard in Black. Other KI standard poly colors are available through a Product Modification Request. No upcharge or fees apply for orders of 20 or more. A net setup fee applies for orders of 19 or less. Please allow up 1 week additional leadtime.

SPECIAL SERVICES

Special Carton Marking

With specially marked information N/C

Shipping

Ships assembled, FOB Green Bay, WI 54302, freight excluded. Freight class 300.

Specifications and prices are subject to change without prior notice.

Learn2® Classroom Furniture (Freight Excluded)

Doni® Seating without Worksurface



Learn2® Classroom Furniture (Freight Excluded)

Doni® Seating without Worksurface

| Features | MODEL NUMBER | | | | | | | Approx. Packaged Weight | Freight Excluded Pricing Unupholstered | Freight Excluded Pricing Fabric Grade 1, C.O.M. & COV | Freight Excluded Pricing Fabric Grade 2 | Freight Excluded Pricing Fabric Grade 3 & Group 2V Vinyl | Freight Excluded Pricing Pallas Fabric Group P0 | Freight Excluded Pricing Pallas Fabric Group P1 | Freight Excluded Pricing Pallas Fabric Group P2 | Freight Excluded Pricing Pallas Fabric Group P3 | Freight Excluded Pricing Pallas Fabric Group P4 |
|------------------------------------------------------------------------------------------------------------------------------------------------------------------------------------------------------------------------------------------------------------------------------------------------------------------------------------------------------|-------------------------------|-------------|--------------------------|--------------------------|---------------------------|--------------------------|--------------------------|-------------------------|----------------------------------------|-------------------------------------------------------|-----------------------------------------|----------------------------------------------------------|-------------------------------------------------|-------------------------------------------------|-------------------------------------------------|-------------------------------------------------|-------------------------------------------------|
| | Basic Model | Frame Color | Fire Code | Poly Solid Color | Poly Outside/Inside Color | Glide Option | Uph. Color | | | | | | | | | | |
|  <p>2DNS1 2DNS2 2DNSA 2DNSB</p> <p>No Work Surface - Without Accessory Rack</p> <ul style="list-style-type: none"> • Solid or two-tone colored shell • Unlimited color match's • 17 degrees of hip articulation | Solid Color, Polypropylene | L2DN1/NAR | <input type="checkbox"/> | <input type="checkbox"/> | <input type="checkbox"/> | <input type="checkbox"/> | <input type="checkbox"/> | 57.0# | \$ 657 | | | | | | | | |
| | Solid Color, Upholstered Seat | L2DN2/NAR | <input type="checkbox"/> | <input type="checkbox"/> | <input type="checkbox"/> | <input type="checkbox"/> | <input type="checkbox"/> | 57.0# | N/A | 793 | 803 | 822 | 831 | 880 | 897 | 919 | 951 |
| | Two-Tone, Polypropylene | L2DNA/NAR | <input type="checkbox"/> | NFR | <input type="checkbox"/> | <input type="checkbox"/> | <input type="checkbox"/> | 57.0# | 721 | | | | | | | | |
| | Two-Tone, Upholstered Seat | L2DNB/NAR | <input type="checkbox"/> | NFR | <input type="checkbox"/> | <input type="checkbox"/> | <input type="checkbox"/> | 57.0# | N/A | 857 | 866 | 886 | 897 | 944 | 959 | 983 | 1019 |
| | Solid Color, Polypropylene | L2DN1/SAR | <input type="checkbox"/> | <input type="checkbox"/> | <input type="checkbox"/> | <input type="checkbox"/> | <input type="checkbox"/> | 57.0# | \$ 683 | | | | | | | | |
| | Solid Color, Upholstered Seat | L2DN2/SAR | <input type="checkbox"/> | <input type="checkbox"/> | <input type="checkbox"/> | <input type="checkbox"/> | <input type="checkbox"/> | 57.0# | N/A | 819 | 829 | 851 | 859 | 905 | 924 | 947 | 980 |
| | Two-Tone, Polypropylene | L2DNA/SAR | <input type="checkbox"/> | NFR | <input type="checkbox"/> | <input type="checkbox"/> | <input type="checkbox"/> | 57.0# | 748 | | | | | | | | |
| | Two-Tone, Upholstered Seat | L2DNB/SAR | <input type="checkbox"/> | NFR | <input type="checkbox"/> | <input type="checkbox"/> | <input type="checkbox"/> | 57.0# | N/A | 884 | 895 | 912 | 924 | 970 | 987 | 1011 | 1044 |

HOW TO ORDER

- Indicate the following information on order form:
- Quantity of each item.
 - Model number, including options. See "How To Build a Model Number".
 - Any special service required.

Note: • The indicates that a choice is required.
 • The absence of the indicates that no choice is required.
 • Alpha-numeric characters in place of indicate that no other alternatives are available.

HOW TO BUILD A MODEL NUMBER

- A** Select basic model.
- B** Select frame color. Refer to the **Product Color Options** page in this price list.
- C** Select fire code.
 NFR - Compliance to TB 117-2013
 FR - Compliance to TB 133
- D** Select solid poly color. Refer to the **Product Color Options** page in this price list.
- E** Select outside/inside poly color. Refer to the **Product Color Options** page in this price list.
- F** Select caster/glide option.
 C - Carpet casters
 S - Hard floor casters
 GL - Glides
 SCG - Front hard floor casters, rear

glides
CCG - Front carpet casters, rear glides

G Select upholstery grade/color. Refer to ki.com/fabrics

UPHOLSTERY INFORMATION

C.O.M. Upholstery
 C.O.M. requirement for 10 chairs or less with upholstered seat or upholstered seat and back is 3/4 yard per chair of 54" wide nondirectional fabric. For orders of 11 or more with upholstered seat and back and for complete information on ordering C.O.M. see "Ordering C.O.M., C.O.V. and C.O.L." section.

California TB133 Fire Safety Code
 For California Technical Bulletin 133 compliant models, add the following upcharge:
 Model=Solid Color, Polypropylene
 Added List Price=\$13
 Model=Solid Color, Upholstered Seat
 Added List Price=\$81

SPECIAL SERVICES

Special Carton Marking
 With specially marked information N/C

Shipping
 Ships assembled, FOB Green Bay, WI 54302, freight excluded. Freight class 300.

Specifications and prices are subject to change without prior notice.

Learn2® Classroom Furniture (Freight Excluded)

Doni® Seating without Worksurface



Learn2® Classroom Furniture (Freight Excluded)

Doni® Seating without Worksurface

| Features | MODEL NUMBER | | | | | | | Approx. Packaged Weight | Freight Excluded Pricing Upholstered | Freight Excluded Pricing Fabric Grade 1, C.O.M. & COV | Freight Excluded Pricing Fabric Grade 2 | Freight Excluded Pricing Fabric Grade 3 & Group 2V Vinyl | Freight Excluded Pricing Pallas Fabric Group P0 | Freight Excluded Pricing Pallas Fabric Group P1 | Freight Excluded Pricing Pallas Fabric Group P2 | Freight Excluded Pricing Pallas Fabric Group P3 | Freight Excluded Pricing Pallas Fabric Group P4 |
|-------------------------------|--------------|--------------------------|--------------------------|--------------------------|---------------------------|--------------------------|--------------------------|-------------------------|--------------------------------------|-------------------------------------------------------|-----------------------------------------|----------------------------------------------------------|-------------------------------------------------|-------------------------------------------------|-------------------------------------------------|-------------------------------------------------|-------------------------------------------------|
| | Basic Model | Frame Color | Fire Code | Poly Solid Color | Poly Outside/Inside Color | Glide Option | Uph. Color | | | | | | | | | | |
| Solid Color, Polypropylene | L2DN1/CAR | <input type="checkbox"/> | <input type="checkbox"/> | <input type="checkbox"/> | | <input type="checkbox"/> | | 57.0# | \$ 727 | | | | | | | | |
| Solid Color, Upholstered Seat | L2DN2/CAR | <input type="checkbox"/> | <input type="checkbox"/> | <input type="checkbox"/> | | <input type="checkbox"/> | <input type="checkbox"/> | 57.0# | N/A | 862 | 872 | 892 | 903 | 949 | 968 | 989 | 1023 |
| Two-Tone, Polypropylene | L2DNA/CAR | <input type="checkbox"/> | NFR | | <input type="checkbox"/> | <input type="checkbox"/> | | 57.0# | 791 | | | | | | | | |
| Two-Tone, Upholstered Seat | L2DNB/CAR | <input type="checkbox"/> | NFR | | <input type="checkbox"/> | <input type="checkbox"/> | <input type="checkbox"/> | 57.0# | N/A | 929 | 936 | 956 | 968 | 1013 | 1029 | 1054 | 1087 |
| | | | | | | | | | | | | | | | | | |
| | | | | | | | | | | | | | | | | | |
| | | | | | | | | | | | | | | | | | |
| | | | | | | | | | | | | | | | | | |
| | | | | | | | | | | | | | | | | | |
| | | | | | | | | | | | | | | | | | |
| | | | | | | | | | | | | | | | | | |
| | | | | | | | | | | | | | | | | | |



2DNS1
2DNS2
2DNSA
2DNSB

- No Worksurface - Cup Holder/Accessory Rack**
- Cup holder/accessory rack included on both sides of frame
 - Solid or two-tone colored shell
 - Unlimited color match's
 - 17 degrees of hip articulation

A **B** **C** **D** **E** **F** **G**

HOW TO ORDER

Indicate the following information on order form:

- Quantity of each item.
- Model number, including options. See "How To Build a Model Number".
- Any special service required.

Note:

- The indicates that a choice is required.
- The absence of the indicates that no choice is required.
- Alpha-numeric characters in place of indicate that no other alternatives are available.

HOW TO BUILD A MODEL NUMBER

A Select basic model.

B Select frame color. Refer to the **Product Color Options** page in this price list.

C Select fire code.
NFR - Compliance to TB 117-2013
FR - Compliance to TB 133

D Select solid poly color. Refer to the **Product Color Options** page in this price list.

E Select outside/inside poly color. Refer to the **Product Color Options** page in this price list.

F Select caster/glide option.
C - Carpet casters
S - Hard floor casters
GL - Glides
SCG - Front hard floor casters, rear glides

G Select upholstery grade/color. Refer to ki.com/fabrics

UPHOLSTERY INFORMATION

C.O.M. Upholstery
 C.O.M. requirement for 10 chairs or less with upholstered seat or upholstered seat and back is 3/4 yard per chair of 54" wide nondirectional fabric. For orders of 11 or more with upholstered seat and back and for complete information on ordering C.O.M. see "Ordering C.O.M., C.O.V. and C.O.L." section.

California TB133 Fire Safety Code
 For California Technical Bulletin 133 compliant models, add the following upcharge:
 Model=Solid Color, Polypropylene
 Added List Price=\$13
 Model=Solid Color, Upholstered Seat
 Added List Price=\$81

SPECIAL SERVICES

Special Carton Marking
 With specially marked information N/C

Shipping
 Ships assembled, FOB Green Bay, WI 54302, freight excluded. Freight class 300.

Specifications and prices are subject to change without prior notice.

Learn2® Classroom Furniture (Freight Excluded)

Doni® Seating without Worksurface



Learn2® Classroom Furniture (Freight Excluded)

Doni® Seating without Worksurface

| Features | MODEL NUMBER | | | | | | | Approx. Packaged Weight | Freight Excluded Pricing Unupholstered | Freight Excluded Pricing Fabric Grade 1, C.O.M. & COV | Freight Excluded Pricing Fabric Grade 2 | Freight Excluded Pricing Fabric Grade 3 & Group 2V Vinyl | Freight Excluded Pricing Pallas Fabric Group P0 | Freight Excluded Pricing Pallas Fabric Group P1 | Freight Excluded Pricing Pallas Fabric Group P2 | Freight Excluded Pricing Pallas Fabric Group P3 | Freight Excluded Pricing Pallas Fabric Group P4 |
|-------------------------------------------------------------------------------------------------------------------------------------------------------------------------------------------------------------------------------------------|--------------|---------------------------------------------------|----------------------------------------------------------------------------|----------------------------------------------------------------------------|-------------------------------------------------------------------------------------------------------------------------------------------------------|---------------------------------------------------|----------------------------------------------------------------------------|-------------------------|----------------------------------------|-------------------------------------------------------|-----------------------------------------|----------------------------------------------------------|-------------------------------------------------|-------------------------------------------------|-------------------------------------------------|-------------------------------------------------|-------------------------------------------------|
| | Basic Model | Frame Color | Fire Code | Poly Solid Color | Poly Outside/Inside Color | Glide Option | Uph. Color | | | | | | | | | | |
| Solid Color, Polypropylene | L2DN1/PBR | <input type="checkbox"/> <input type="checkbox"/> | <input type="checkbox"/> <input type="checkbox"/> <input type="checkbox"/> | <input type="checkbox"/> <input type="checkbox"/> <input type="checkbox"/> | | <input type="checkbox"/> <input type="checkbox"/> | | 57.0# | \$ 705 | | | | | | | | |
| Solid Color, Upholstered Seat | L2DN2/PBR | <input type="checkbox"/> <input type="checkbox"/> | <input type="checkbox"/> <input type="checkbox"/> <input type="checkbox"/> | <input type="checkbox"/> <input type="checkbox"/> <input type="checkbox"/> | | <input type="checkbox"/> <input type="checkbox"/> | <input type="checkbox"/> <input type="checkbox"/> <input type="checkbox"/> | 57.0# | N/A | 842 | 852 | 871 | 881 | 929 | 946 | 968 | 1000 |
| Two-Tone, Polypropylene | L2DNA/PBR | <input type="checkbox"/> <input type="checkbox"/> | NFR | | <input type="checkbox"/> <input type="checkbox"/> <input type="checkbox"/> <input type="checkbox"/> <input type="checkbox"/> <input type="checkbox"/> | <input type="checkbox"/> <input type="checkbox"/> | | 57.0# | 769 | | | | | | | | |
| Two-Tone, Upholstered Seat | L2DNB/PBR | <input type="checkbox"/> <input type="checkbox"/> | NFR | | <input type="checkbox"/> <input type="checkbox"/> <input type="checkbox"/> <input type="checkbox"/> <input type="checkbox"/> <input type="checkbox"/> | <input type="checkbox"/> <input type="checkbox"/> | <input type="checkbox"/> <input type="checkbox"/> <input type="checkbox"/> | 57.0# | N/A | 906 | 915 | 935 | 946 | 993 | 1008 | 1033 | 1067 |
| <div style="display: flex; justify-content: space-around; width: 100%;"> A B C D E F G </div> | | | | | | | | | | | | | | | | | |



- 2DNS1
- 2DNS2
- 2DNSA
- 2DNSB

No Worksurface - Poly Bookbag Rack

- Poly bookbag rack included
- Poly bookbag rack includes two accessory slots and a cupholder
- Poly Bookbag rack is only available in black
- Solid or two-tone colored shell
- Unlimited color match's
- 17 degrees of hip articulation

HOW TO ORDER

- Indicate the following information on order form:
1. Quantity of each item.
 2. Model number, including options. See "How To Build a Model Number".
 3. Any special service required.

- Note:
- The indicates that a choice is required.
 - The absence of the indicates that no choice is required.
 - Alpha-numeric characters in place of indicate that no other alternatives are available.

HOW TO BUILD A MODEL NUMBER

- A** Select basic model.
- B** Select frame color.
Refer to the **Product Color Options** page in this price list.
- C** Select fire code.
NFR - Compliance to TB 117-2013
FR - Compliance to TB 133
- D** Select solid poly color.
Refer to the **Product Color Options** page in this price list.
- E** Select outside/inside poly color.
Refer to the **Product Color Options** page in this price list.

- F** Select caster/glide option.
C - Carpet casters
S - Hard floor casters
GL - Glides
SCG - Front hard floor casters, rear

- G** Select upholstery grade/color.
Refer to ki.com/fabrics

UPHOLSTERY INFORMATION

C.O.M. Upholstery

C.O.M. requirement for 10 chairs or less with upholstered seat or upholstered seat and back is 3/4 yard per chair of 54" wide nondirectional fabric. For orders of 11 or more with upholstered seat and back and for complete information on ordering C.O.M. see "Ordering C.O.M., C.O.V. and C.O.L." section.

California TB133 Fire Safety Code

For California Technical Bulletin 133 compliant models, add the following upcharge:
Model=Solid Color, Polypropylene
Added List Price=\$13
Model=Solid Color, Upholstered Seat
Added List Price=\$81

FINISH INFORMATION

Poly Bookbag Rack comes standard in Black. Other KI standard poly colors are available through a Product Modification Request. No upcharge or fees apply for orders of 20 or more. A net setup fee applies for orders of 19 or less. Please allow up 1 week additional leadtime.

SPECIAL SERVICES

Special Carton Marking

With specially marked information N/C

Shipping

Ships **assembled, FOB Green Bay, WI 54302, freight excluded.** Freight class 300.

Specifications and prices are subject to change without prior notice.

Learn2® Classroom Furniture (Freight Excluded)

Doni® Seating without Worksurface



Learn2® Classroom Furniture (Freight Excluded)

Doni® Seating without Worksurface

| MODEL | Features | MODEL NUMBER | | | | | | | Approx. Packaged Weight | Freight Excluded Pricing Unupholstered | Freight Excluded Pricing Fabric Grade 1, C.O.M. & COV | Freight Excluded Pricing Fabric Grade 2 | Freight Excluded Pricing Fabric Grade 3 & Group 2V Vinyl | Freight Excluded Pricing Pallas Fabric Group P0 | Freight Excluded Pricing Pallas Fabric Group P1 | Freight Excluded Pricing Pallas Fabric Group P2 | Freight Excluded Pricing Pallas Fabric Group P3 | Freight Excluded Pricing Pallas Fabric Group P4 | |
|---------------------------------------------------------------------------------------------------------------------------------------------------------------------------------------------------------------------------------------------------------------------------------------------------------------------------------------|-------------------------------|--------------|--------------------------|--------------------------|--------------------------|---------------------------|--------------------------|--------------------------|-------------------------|----------------------------------------|-------------------------------------------------------|-----------------------------------------|----------------------------------------------------------|-------------------------------------------------|-------------------------------------------------|-------------------------------------------------|-------------------------------------------------|-------------------------------------------------|--|
| | | Basic Model | Frame Color | Fire Code | Poly Solid Color | Poly Outside/Inside Color | Glide Option | Uph. Color | | | | | | | | | | | |
|  <p>No Worksurface - Flat Accessory Rack</p> <ul style="list-style-type: none"> Flat accessory rack included Solid or two-tone colored shell Unlimited color match's 17 degrees of hip articulation | Solid Color, Polypropylene | L2DN1/FBR | <input type="checkbox"/> | <input type="checkbox"/> | <input type="checkbox"/> | | <input type="checkbox"/> | | 57.0# | \$ 727 | | | | | | | | | |
| | Solid Color, Upholstered Seat | L2DN2/FBR | <input type="checkbox"/> | <input type="checkbox"/> | <input type="checkbox"/> | | <input type="checkbox"/> | <input type="checkbox"/> | 57.0# | N/A | 862 | 872 | 892 | 903 | 949 | 968 | 989 | 1023 | |
| | Two-Tone, Polypropylene | L2DNA/FBR | <input type="checkbox"/> | NFR | | <input type="checkbox"/> | <input type="checkbox"/> | <input type="checkbox"/> | 57.0# | 791 | | | | | | | | | |
| | Two-Tone, Upholstered Seat | L2DNB/FBR | <input type="checkbox"/> | NFR | | <input type="checkbox"/> | <input type="checkbox"/> | <input type="checkbox"/> | 57.0# | N/A | 929 | 936 | 956 | 968 | 1013 | 1029 | 1054 | 1087 | |
| | | | | | | | | | | | | | | | | | | | |
| | | | | | | | | | | | | | | | | | | | |
| | | | | | | | | | | | | | | | | | | | |
| | | | | | | | | | | | | | | | | | | | |
| | | | | | | | | | | | | | | | | | | | |

2DNS1
2DNS2
2DNSA
2DNSB

A **B** **C** **D** **E** **F** **G**

HOW TO ORDER

- Indicate the following information on order form:
- Quantity of each item.
 - Model number, including options. See "How To Build a Model Number".
 - Any special service required.

Note:

- The indicates that a choice is required.
- The absence of the indicates that no choice is required.
- Alpha-numeric characters in place of indicate that no other alternatives are available.

HOW TO BUILD A MODEL NUMBER

- A** Select basic model.
- B** Select frame color. Refer to the **Product Color Options** page in this price list.
- C** Select fire code.

| | |
|------------|-----------------------------|
| NFR | - Compliance to TB 117-2013 |
| FR | - Compliance to TB 133 |
- D** Select solid poly color. Refer to the **Product Color Options** page in this price list.
- E** Select outside/inside poly color. Refer to the **Product Color Options** page in this price list.
- F** Select caster/glide option.

| | |
|------------|----------------------------------|
| C | - Carpet casters |
| S | - Hard floor casters |
| GL | - Glides |
| SCG | - Front hard floor casters, rear |

glides
CCG - Front carpet casters, rear glides

G Select upholstery grade/color. Refer to ki.com/fabrics

UPHOLSTERY INFORMATION

C.O.M. Upholstery
C.O.M. requirement for 10 chairs or less with upholstered seat or upholstered seat and back is 3/4 yard per chair of 54" wide nondirectional fabric. For orders of 11 or more with upholstered seat and back and for complete information on ordering C.O.M. see "Ordering C.O.M., C.O.V. and C.O.L." section.

California TB133 Fire Safety Code
For California Technical Bulletin 133 compliant models, add the following upcharge:
Model=Solid Color, Polypropylene
Added List Price=\$13
Model=Solid Color, Upholstered Seat
Added List Price=\$81

SPECIAL SERVICES

Special Carton Marking

With specially marked information N/C

Shipping
Ships assembled, FOB Green Bay, WI 54302, freight excluded. Freight class 300.

Specifications and prices are subject to change without prior notice.



Learn2® Classroom Furniture (Freight Excluded)

Intellect Wave® Seating without Worksurface



Learn2® Classroom Furniture (Freight Excluded)

Intellect Wave® Seating without Worksurface

| MODEL | Features | MODEL NUMBER | | | | | | Approx. Packaged Weight | Freight Excluded Pricing | Freight Excluded Pricing Fabric Grade 1, C.O.M. & COV | Freight Excluded Pricing Fabric Grade 2 | Freight Excluded Pricing Fabric Grade 3 & Group 2V Vinyl | Freight Excluded Pricing Pallas Fabric Group P0 | Freight Excluded Pricing Pallas Fabric Group P1 | Freight Excluded Pricing Pallas Fabric Group P2 | Freight Excluded Pricing Pallas Fabric Group P3 | Freight Excluded Pricing Pallas Fabric Group P4 |
|------------------------------------------------------------------------------------------------------|------------------------------------------------------------------------------------------------------------------|------------------|-------------|--------------------------|--------------------------|--------------------------|--------------------------|--------------------------|--------------------------|-------------------------------------------------------|-----------------------------------------|----------------------------------------------------------|-------------------------------------------------|-------------------------------------------------|-------------------------------------------------|-------------------------------------------------|-------------------------------------------------|
| | | Basic Model | Frame Color | Fire Code | Shell Color | Glide Option | Upholstery Color | | | | | | | | | | |
|  2WNSP 2WNSU | No Worksurface - Without Accessory Rack | Polypropylene | L2WNP/NAR | <input type="checkbox"/> | <input type="checkbox"/> | <input type="checkbox"/> | <input type="checkbox"/> | 33.0# | \$ 498 | | | | | | | | |
| | | Upholstered Seat | L2WNUS/NAR | <input type="checkbox"/> | <input type="checkbox"/> | <input type="checkbox"/> | <input type="checkbox"/> | <input type="checkbox"/> | 36.0# | N/A | 565 | 568 | 580 | 568 | 613 | 632 | 651 |
|  2WNSP 2WNSU | No Worksurface - Accessory Rack • Accessory rack included on both sides of frame | Polypropylene | L2WNP/SAR | <input type="checkbox"/> | <input type="checkbox"/> | <input type="checkbox"/> | <input type="checkbox"/> | 42.0# | \$ 522 | | | | | | | | |
| | | Upholstered Seat | L2WNUS/SAR | <input type="checkbox"/> | <input type="checkbox"/> | <input type="checkbox"/> | <input type="checkbox"/> | <input type="checkbox"/> | 45.0# | N/A | 591 | 596 | 607 | 596 | 642 | 658 | 677 |
|  2WNSP 2WNSU | No Worksurface - Cup Holder/Accessory Rack • Cup holder/accessory rack included on both sides of frame | Polypropylene | L2WNP/CAR | <input type="checkbox"/> | <input type="checkbox"/> | <input type="checkbox"/> | <input type="checkbox"/> | 42.0# | \$ 567 | | | | | | | | |
| | | Upholstered Seat | L2WNUS/CAR | <input type="checkbox"/> | <input type="checkbox"/> | <input type="checkbox"/> | <input type="checkbox"/> | <input type="checkbox"/> | 45.0# | N/A | 635 | 638 | 649 | 638 | 686 | 702 | 721 |

A **B** **C** **D** **E** **F**

HOW TO ORDER

- Indicate the following information on order form:
- Quantity of each item.
 - Model number, including options. See "How To Build a Model Number".
 - Any special service required.

Note: • The indicates that a choice is required.
 • The absence of the indicates that no choice is required.
 • Alpha-numeric characters in place of indicate that no other alternatives are available.

HOW TO BUILD A MODEL NUMBER

- A** Select basic model.
- B** Select frame color. Refer to the **Product Color Options** page in this price list.
- C** Select fire code.
 - FR** - Compliance to TB 133
 - NFR** - Compliance to TB 117-2013
 See Upholstery Information for TB133 upcharge.
- D** Select shell color. Refer to the **Product Color Options** page in this price list.
- E** Select caster/glide option.
 - C** - Carpet casters
 - S** - Hard floor casters
 - GL** - Glides
 - SCG** - Front hard floor casters, rear glides
 - CCG** - Front carpet casters, rear glides
- F** Select upholstery grade/color. Refer to ki.com/fabrics

UPHOLSTERY INFORMATION

C.O.M. Upholstery
 C.O.M. requirement is 5/8 yard per chair for seat of 54" wide nondirectional fabric. For complete information on ordering C.O.M. see "Ordering C.O.M., C.O.V. and C.O.L." section.

California TB133 Fire Safety Code
 For California Technical Bulletin 133 compliant models, add the following upcharge:
 Model=Polypropylene
 Added List Price=\$26
 Model=Upholstered Seat
 Added List Price=\$76

SPECIAL SERVICES

Special Carton Marking

With specially marked information N/C

Shipping
 Ships assembled, FOB Green Bay, WI 54302, freight excluded. Freight class 300.

Specifications and prices are subject to change without prior notice.



Learn2® Classroom Furniture (Freight Excluded)

Intellect Wave® Seating without Worksurface



Learn2® Classroom Furniture (Freight Excluded)

Intellect Wave® Seating without Worksurface

| MODEL | Features | MODEL NUMBER | | | | | | Approx. Packaged Weight | Freight Excluded Pricing | Freight Excluded Pricing Fabric Grade 1, C.O.M. & COV | Freight Excluded Pricing Fabric Grade 2 | Freight Excluded Pricing Fabric Grade 3 & Group 2V Vinyl | Freight Excluded Pricing Pallas Fabric Group P0 | Freight Excluded Pricing Pallas Fabric Group P1 | Freight Excluded Pricing Pallas Fabric Group P2 | Freight Excluded Pricing Pallas Fabric Group P3 | Freight Excluded Pricing Pallas Fabric Group P4 |
|-----------------------------------------------------------------------------------------------------|-------------------------------------------------------------------------------------------------------------------------------------------------------------------------------------------------|------------------|-------------|--------------------------|--------------------------|--------------------------|--------------------------|--------------------------|--------------------------|-------------------------------------------------------|-----------------------------------------|----------------------------------------------------------|-------------------------------------------------|-------------------------------------------------|-------------------------------------------------|-------------------------------------------------|-------------------------------------------------|
| | | Basic Model | Frame Color | Fire Code | Shell Color | Glide Option | Upholstery Color | | | | | | | | | | |
|  2WNSP 2WNSU | No Worksurface - Poly Bookbag Rack • Poly bookbag rack included • Poly bookbag rack includes two accessory slots and a cupholder • Poly Bookbag rack is only available in black | Polypropylene | L2WNP/PBR | <input type="checkbox"/> | <input type="checkbox"/> | <input type="checkbox"/> | <input type="checkbox"/> | 42.0# | \$ 547 | | | | | | | | |
| | | Upholstered Seat | L2WNUS/PBR | <input type="checkbox"/> | <input type="checkbox"/> | <input type="checkbox"/> | <input type="checkbox"/> | <input type="checkbox"/> | 45.0# | N/A | 613 | 617 | 629 | 617 | 662 | 682 | 700 |
|  2WNSP 2WNSU | No Worksurface - Flat Accessory Rack • Flat accessory rack included | Polypropylene | L2WNP/FBR | <input type="checkbox"/> | <input type="checkbox"/> | <input type="checkbox"/> | <input type="checkbox"/> | 42.0# | \$ 567 | | | | | | | | |
| | | Upholstered Seat | L2WNUS/FBR | <input type="checkbox"/> | <input type="checkbox"/> | <input type="checkbox"/> | <input type="checkbox"/> | <input type="checkbox"/> | 45.0# | N/A | 635 | 638 | 649 | 638 | 686 | 702 | 721 |

A **B** **C** **D** **E** **F**

HOW TO ORDER

- Indicate the following information on order form:
- Quantity of each item.
 - Model number, including options. See "How To Build a Model Number".
 - Any special service required.

Note: • The indicates that a choice is required.
 • The absence of the indicates that no choice is required.
 • Alpha-numeric characters in place of indicate that no other alternatives are available.

HOW TO BUILD A MODEL NUMBER

- A** Select basic model.
- B** Select frame color. Refer to the **Product Color Options** page in this price list.
- C** Select fire code.
 - FR** - Compliance to TB 133
 - NFR** - Compliance to TB 117-2013
 See Upholstery Information for TB133 upcharge.
- D** Select shell color. Refer to the **Product Color Options** page in this price list.
- E** Select caster/glide option.
 - C** - Carpet casters
 - S** - Hard floor casters
 - GL** - Glides
 - SCG** - Front hard floor casters, rear glides
 - CCG** - Front carpet casters, rear glides
- F** Select upholstery grade/color. Refer to ki.com/fabrics

UPHOLSTERY INFORMATION

C.O.M. Upholstery
 C.O.M. requirement is 5/8 yard per chair for seat of 54" wide nondirectional fabric. For complete information on ordering C.O.M. see "Ordering C.O.M., C.O.V. and C.O.L." section.

California TB133 Fire Safety Code
 For California Technical Bulletin 133 compliant models, add the following upcharge:
 Model=Polypropylene
 Added List Price=\$26
 Model=Upholstered Seat
 Added List Price=\$76

FINISH INFORMATION

Poly Bookbag Rack comes standard in Black. Other KI standard poly colors are available through a Product Modification Request. No upcharge or fees apply for orders of 20 or more. A net setup fee applies for orders of 19 or less. Please allow up 1 week additional leadtime.

SPECIAL SERVICES

Special Carton Marking
 With specially marked information N/C

Shipping
 Ships **assembled, FOB Green Bay, WI 54302, freight excluded.** Freight class 300.

Specifications and prices are subject to change without prior notice.



Learn2® Classroom Furniture (Freight Excluded)

LimeLite™ Seating without Worksurface



Learn2® Classroom Furniture (Freight Excluded)

LimeLite™ Seating without Worksurface

| MODEL | Features | MODEL NUMBER | | | | | | Approx. Packaged Weight | Freight Excluded Pricing | Freight Excluded Pricing Fabric Grade 1, C.O.M. & COV | Freight Excluded Pricing Fabric Grade 2 | Freight Excluded Pricing Fabric Grade 3 & Group 2V Vinyl | Freight Excluded Pricing Pallas Fabric Group P0 | Freight Excluded Pricing Pallas Fabric Group P1 | Freight Excluded Pricing Pallas Fabric Group P2 | Freight Excluded Pricing Pallas Fabric Group P3 | Freight Excluded Pricing Pallas Fabric Group P4 |
|-----------------------------------------------------------------------------------------------------|---------------------------------------------------------------------------------------------------------------------------------------------------------------------------------------------------------------------------|------------------|--------------|--------------------------|--------------------------|--------------------------|--------------------------|--------------------------|--------------------------|-------------------------------------------------------|-----------------------------------------|----------------------------------------------------------|-------------------------------------------------|-------------------------------------------------|-------------------------------------------------|-------------------------------------------------|-------------------------------------------------|
| | | Basic Model | Frame Color | Fire Code | Shell Color | Glide Option | Uph. Color | | | | | | | | | | |
|  2LNS1 2LNS2 | No Worksurface - Without Accessory Rack • One-piece shell • Passive back flex • Non-handed worksurface in choice of plastic or laminate | Polypropylene | L2LN1/NA/NAR | <input type="checkbox"/> | <input type="checkbox"/> | <input type="checkbox"/> | <input type="checkbox"/> | 45.0# | \$ 638 | | | | | | | | |
| | | Upholstered Seat | L2LN2/NA/NAR | <input type="checkbox"/> | <input type="checkbox"/> | <input type="checkbox"/> | <input type="checkbox"/> | <input type="checkbox"/> | 47.0# | N/A | 707 | 707 | 738 | 746 | 794 | 816 | 840 |
|  2LNS1 2LNS2 | No Worksurface - Accessory Rack • One-piece shell • Passive back flex • Non-handed worksurface in choice of plastic or laminate • Accessory rack included on both sides of frame | Polypropylene | L2LN1/NA/SAR | <input type="checkbox"/> | <input type="checkbox"/> | <input type="checkbox"/> | <input type="checkbox"/> | 53.0# | \$ 664 | | | | | | | | |
| | | Upholstered Seat | L2LN2/NA/SAR | <input type="checkbox"/> | <input type="checkbox"/> | <input type="checkbox"/> | <input type="checkbox"/> | <input type="checkbox"/> | 55.0# | N/A | 731 | 762 | 778 | 770 | 818 | 840 | 864 |
|  2LNS1 2LNS2 | No Worksurface - Cup Holder/Accessory Rack • One-piece shell • Passive back flex • Non-handed worksurface in choice of plastic or laminate • Cup holder/accessory rack included on both sides of frame | Polypropylene | L2LN1/NA/CAR | <input type="checkbox"/> | <input type="checkbox"/> | <input type="checkbox"/> | <input type="checkbox"/> | 53.0# | \$ 708 | | | | | | | | |
| | | Upholstered Seat | L2LN2/NA/CAR | <input type="checkbox"/> | <input type="checkbox"/> | <input type="checkbox"/> | <input type="checkbox"/> | <input type="checkbox"/> | 55.0# | N/A | 774 | 805 | 821 | 813 | 861 | 883 | 907 |

A **B** **C** **D** **E** **F**

HOW TO ORDER

- Indicate the following information on order form:
- Quantity of each item.
 - Model number, including options. See "How To Build a Model Number".
 - Any special service required.

Note: • The indicates that a choice is required.
 • The absence of the indicates that no choice is required.
 • Alpha-numeric characters in place of indicate that no other alternatives are available.

HOW TO BUILD A MODEL NUMBER

- A** Select basic model.
- B** Select frame color. Refer to the **Product Color Options** page in this price list.
- C** Select fire code.

| | |
|------------|-----------------------------|
| NFR | - Compliance to TB 117-2013 |
| FR | - Compliance to TB 133 |

 See Upholstery Information for TB133 upcharge.
- D** Select poly seat and back color. Refer to the **Product Color Options** page in this price list.
- E** Select caster/glide option.

| | |
|------------|-----------------------------------------|
| C | - Carpet casters |
| S | - Hard floor casters |
| GL | - Glides |
| SCG | - Front hard floor casters, rear glides |
| CCG | - Front carpet casters, rear glides |
- F** Select upholstery grade/color. Refer to ki.com/fabrics

UPHOLSTERY INFORMATION

C.O.M. Upholstery
 C.O.M. requirement for 10 chairs or less with upholstered seat or upholstered seat and back is 3/4 yard per chair of 54" wide nondirectional fabric. For orders of 11 or more with upholstered seat and back and for complete information on ordering C.O.M. see "Ordering C.O.M., C.O.V. and C.O.L." section.

California TB133 Fire Safety Code
 For California Technical Bulletin 133 compliant models, add the following upcharge:
 Model=Polypropylene
 Added List Price=\$13
 Model=Upholstered Seat
 Added List Price=\$78

SPECIAL SERVICES

Special Carton Marking
 With specially marked information N/C

Shipping
 Ships assembled, FOB Green Bay, WI 54302, freight excluded. Freight class 300.

Specifications and prices are subject to change without prior notice.



Learn2® Classroom Furniture (Freight Excluded)

LimeLite™ Seating without Worksurface



Learn2® Classroom Furniture (Freight Excluded)

LimeLite™ Seating without Worksurface

| MODEL | Features | MODEL NUMBER | | | | | | Approx. Packaged Weight | Freight Excluded Pricing | Freight Excluded Pricing Fabric Grade 1, C.O.M. & COV | Freight Excluded Pricing Fabric Grade 2 | Freight Excluded Pricing Fabric Grade 3 & Group 2V Vinyl | Freight Excluded Pricing Pallas Fabric Group P0 | Freight Excluded Pricing Pallas Fabric Group P1 | Freight Excluded Pricing Pallas Fabric Group P2 | Freight Excluded Pricing Pallas Fabric Group P3 | Freight Excluded Pricing Pallas Fabric Group P4 |
|-----------------------------------------------------------------------------------------------------|----------------------------------------------------------------------------------------------------------------------------------------------------------------------------------------------------------------------------------------------------------------------------------------------------------|------------------|--------------|--------------------------|--------------------------|--------------------------|--------------------------|--------------------------|--------------------------|-------------------------------------------------------|-----------------------------------------|----------------------------------------------------------|-------------------------------------------------|-------------------------------------------------|-------------------------------------------------|-------------------------------------------------|-------------------------------------------------|
| | | Basic Model | Frame Color | Fire Code | Shell Color | Glide Option | Uph. Color | | | | | | | | | | |
|  2LNS1 2LNS2 | No Worksurface - Poly Bookbag Rack • One-piece shell • Passive back flex • Non-handed worksurface in choice of plastic or laminate • Poly bookbag rack included • Poly bookbag rack includes two accessory slots and a cupholder • Poly Bookbag rack is only available in black | Polypropylene | L2LN1/NA/PBR | <input type="checkbox"/> | <input type="checkbox"/> | <input type="checkbox"/> | <input type="checkbox"/> | 49.0# | \$ 688 | | | | | | | | |
| | | Upholstered Seat | L2LN2/NA/PBR | <input type="checkbox"/> | <input type="checkbox"/> | <input type="checkbox"/> | <input type="checkbox"/> | <input type="checkbox"/> | 51.0# | N/A | 761 | 792 | 808 | 800 | 848 | 870 | 894 |
|  2LNS1 2LNS2 | No Worksurface - Flat Accessory Rack • One-piece shell • Passive back flex • Non-handed worksurface in choice of plastic or laminate • Flat accessory rack included | Polypropylene | L2LN1/NA/FBR | <input type="checkbox"/> | <input type="checkbox"/> | <input type="checkbox"/> | <input type="checkbox"/> | 55.0# | \$ 708 | | | | | | | | |
| | | Upholstered Seat | L2LN2/NA/FBR | <input type="checkbox"/> | <input type="checkbox"/> | <input type="checkbox"/> | <input type="checkbox"/> | <input type="checkbox"/> | 57.0# | N/A | 774 | 805 | 821 | 813 | 861 | 883 | 907 |

A **B** **C** **D** **E** **F**

HOW TO ORDER

- Indicate the following information on order form:
- Quantity of each item.
 - Model number, including options. See "How To Build a Model Number".
 - Any special service required.

Note: • The indicates that a choice is required.
 • The absence of the indicates that no choice is required.
 • Alpha-numeric characters in place of indicate that no other alternatives are available.

HOW TO BUILD A MODEL NUMBER

- A** Select basic model.
- B** Select frame color.
Refer to the **Product Color Options** page in this price list.
- C** Select fire code.

| | |
|------------|-----------------------------|
| NFR | - Compliance to TB 117-2013 |
| FR | - Compliance to TB 133 |

 See Upholstery Information for TB133 upcharge.
- D** Select poly seat and back color.
Refer to the **Product Color Options** page in this price list.
- E** Select caster/glide option.

| | |
|------------|-----------------------------------------|
| C | - Carpet casters |
| S | - Hard floor casters |
| GL | - Glides |
| SCG | - Front hard floor casters, rear glides |
| CCG | - Front carpet casters, rear glides |

F Select upholstery grade/color.
Refer to ki.com/fabrics

UPHOLSTERY INFORMATION

C.O.M. Upholstery
 C.O.M. requirement for 10 chairs or less with upholstered seat or upholstered seat and back is 3/4 yard per chair of 54" wide nondirectional fabric. For orders of 11 or more with upholstered seat and back and for complete information on ordering C.O.M. see "Ordering C.O.M., C.O.V. and C.O.L." section.

California TB133 Fire Safety Code
 For California Technical Bulletin 133 compliant models, add the following upcharge:
 Model=Polypropylene
 Added List Price=\$13
 Model=Upholstered Seat
 Added List Price=\$78

FINISH INFORMATION

Poly Bookbag Rack comes standard in Black. Other KI standard poly colors are available through a Product Modification Request. No upcharge or fees apply for orders of 20 or more. A net setup fee applies for orders of 19 or less. Please allow up 1 week additional leadtime.

SPECIAL SERVICES

Special Carton Marking

With specially marked information N/C

Shipping
 Ships assembled, FOB Green Bay, WI 54302, freight excluded. Freight class 300.

Specifications and prices are subject to change without prior notice.



Learn2® Classroom Furniture (Freight Excluded)

Strive® Seating without Worksurface



Learn2® Classroom Furniture (Freight Excluded)

Strive® Seating without Worksurface

| MODEL | Features | MODEL NUMBER | | | | | | Approx. Packaged Weight | Freight Excluded Pricing | Freight Excluded Pricing Fabric Grade 1, C.O.M. & COV | Freight Excluded Pricing Fabric Grade 2 | Freight Excluded Pricing Fabric Grade 3 & Group 2V Vinyl | Freight Excluded Pricing Pallas Fabric Group P0 | Freight Excluded Pricing Pallas Fabric Group P1 | Freight Excluded Pricing Pallas Fabric Group P2 | Freight Excluded Pricing Pallas Fabric Group P3 | Freight Excluded Pricing Pallas Fabric Group P4 |
|------------------------------------------------------------------------------------------------------|------------------------------------------------------------------------------------------------------------------|------------------|---------------|--------------------------|--------------------------|--------------------------|--------------------------|--------------------------|--------------------------|-------------------------------------------------------|-----------------------------------------|----------------------------------------------------------|-------------------------------------------------|-------------------------------------------------|-------------------------------------------------|-------------------------------------------------|-------------------------------------------------|
| | | Basic Model | Frame Color | Fire Code | Shell Color | Glide Option | Upholstery Color | | | | | | | | | | |
|  2SNSP 2SNSU | No Worksurface - Without Accessory Rack | Polypropylene | L2SNP/NA/NAR | <input type="checkbox"/> | <input type="checkbox"/> | <input type="checkbox"/> | <input type="checkbox"/> | 44.0# | \$ 632 | | | | | | | | |
| | | Upholstered Seat | L2SNUS/NA/NAR | <input type="checkbox"/> | <input type="checkbox"/> | <input type="checkbox"/> | <input type="checkbox"/> | <input type="checkbox"/> | 47.0# | N/A | 701 | 731 | 746 | 739 | 786 | 807 | 831 |
|  2SNSP 2SNSU | No Worksurface - Accessory Rack • Accessory rack included on both sides of frame | Polypropylene | L2SNP/NA/SAR | <input type="checkbox"/> | <input type="checkbox"/> | <input type="checkbox"/> | <input type="checkbox"/> | 53.0# | \$ 658 | | | | | | | | |
| | | Upholstered Seat | L2SNUS/NA/SAR | <input type="checkbox"/> | <input type="checkbox"/> | <input type="checkbox"/> | <input type="checkbox"/> | <input type="checkbox"/> | 56.0# | N/A | 725 | 759 | 774 | 765 | 813 | 835 | 858 |
|  2SNSP 2SNSU | No Worksurface - Cup Holder/Accessory Rack • Cup holder/accessory rack included on both sides of frame | Polypropylene | L2SNP/NA/CAR | <input type="checkbox"/> | <input type="checkbox"/> | <input type="checkbox"/> | <input type="checkbox"/> | 53.0# | \$ 702 | | | | | | | | |
| | | Upholstered Seat | L2SNUS/NA/CAR | <input type="checkbox"/> | <input type="checkbox"/> | <input type="checkbox"/> | <input type="checkbox"/> | <input type="checkbox"/> | 56.0# | N/A | 768 | 801 | 816 | 808 | 856 | 880 | 902 |

A **B** **C** **D** **E** **F**

HOW TO ORDER

- Indicate the following information on order form:
- Quantity of each item.
 - Model number, including options. See "How To Build a Model Number".
 - Any special service required.

Note: • The indicates that a choice is required.
 • The absence of the indicates that no choice is required.
 • Alpha-numeric characters in place of indicate that no other alternatives are available.

HOW TO BUILD A MODEL NUMBER

- A** Select basic model.
- B** Select frame color.
Refer to the **Product Color Options** page in this price list.
- C** Select fire code.
FR - Compliance to TB 133
NFR - Compliance to TB 117-2013
See Upholstery Information for TB133 upcharge.
- D** Select poly seat and back color.
Refer to the **Product Color Options** page in this price list.
- E** Select caster/glide option.
C - Carpet casters
S - Hard floor casters
GL - Glides
SCG - Front hard floor casters, rear glides
CCG - Front carpet casters, rear glides

F Select upholstery grade/color.
Refer to ki.com/fabrics

UPHOLSTERY INFORMATION

C.O.M. Upholstery
 C.O.M. requirement for 10 chairs or less with upholstered seat or upholstered seat and back is 3/4 yard per chair of 54" wide nondirectional fabric. For orders of 11 or more with upholstered seat and back and for complete information on ordering C.O.M. see "Ordering C.O.M., C.O.V. and C.O.L." section.

California TB133 Fire Safety Code
 For California Technical Bulletin 133 compliant models, add the following upcharge:
 Model=Polypropylene
 Added List Price=\$13
 Model=Upholstered Seat
 Added List Price=\$78

SPECIAL SERVICES

Special Carton Marking

With specially marked information N/C

Shipping
 Ships assembled, FOB Green Bay, WI 54302, freight excluded. Freight class 300.

Specifications and prices are subject to change without prior notice.



Learn2® Classroom Furniture (Freight Excluded)

Strive® Seating without Worksurface



Learn2® Classroom Furniture (Freight Excluded)

Strive® Seating without Worksurface

| MODEL | Features | MODEL NUMBER | | | | | | Approx. Packaged Weight | Freight Excluded Pricing | Freight Excluded Pricing Fabric Grade 1, C.O.M. & COV | Freight Excluded Pricing Fabric Grade 2 | Freight Excluded Pricing Fabric Grade 3 & Group 2V Vinyl | Freight Excluded Pricing Pallas Fabric Group P0 | Freight Excluded Pricing Pallas Fabric Group P1 | Freight Excluded Pricing Pallas Fabric Group P2 | Freight Excluded Pricing Pallas Fabric Group P3 | Freight Excluded Pricing Pallas Fabric Group P4 |
|-----------------------------------------------------------------------------------------------------|-------------------------------------------------------------------------------------------------------------------------------------------------------------------------------------------------|------------------|---------------|--------------------------|--------------------------|--------------------------|--------------------------|--------------------------|--------------------------|-------------------------------------------------------|-----------------------------------------|----------------------------------------------------------|-------------------------------------------------|-------------------------------------------------|-------------------------------------------------|-------------------------------------------------|-------------------------------------------------|
| | | Basic Model | Frame Color | Fire Code | Shell Color | Glide Option | Upholstery Color | | | | | | | | | | |
|  2SNSP 2SNSU | No Worksurface - Poly Bookbag Rack • Poly bookbag rack included • Poly bookbag rack includes two accessory slots and a cupholder • Poly Bookbag rack is only available in black | Polypropylene | L2SNP/NA/PBR | <input type="checkbox"/> | <input type="checkbox"/> | <input type="checkbox"/> | <input type="checkbox"/> | 53.0# | \$ 682 | | | | | | | | |
| | | Upholstered Seat | L2SNUS/NA/PBR | <input type="checkbox"/> | <input type="checkbox"/> | <input type="checkbox"/> | <input type="checkbox"/> | <input type="checkbox"/> | 56.0# | N/A | 750 | 780 | 794 | 789 | 835 | 856 | 881 |
|  2SNSP 2SNSU | No Worksurface - Flat Accessory Rack • Flat accessory rack included | Polypropylene | L2SNP/NA/FBR | <input type="checkbox"/> | <input type="checkbox"/> | <input type="checkbox"/> | <input type="checkbox"/> | 53.0# | \$ 702 | | | | | | | | |
| | | Upholstered Seat | L2SNUS/NA/FBR | <input type="checkbox"/> | <input type="checkbox"/> | <input type="checkbox"/> | <input type="checkbox"/> | <input type="checkbox"/> | 56.0# | N/A | 768 | 801 | 816 | 808 | 856 | 880 | 902 |
| | | | | A | B | C | D | E | F | | | | | | | | |

HOW TO ORDER

- Indicate the following information on order form:
- Quantity of each item.
 - Model number, including options. See "How To Build a Model Number".
 - Any special service required.

Note: • The indicates that a choice is required.
 • The absence of the indicates that no choice is required.
 • Alpha-numeric characters in place of indicate that no other alternatives are available.

HOW TO BUILD A MODEL NUMBER

- A** Select basic model.
- B** Select frame color. Refer to the **Product Color Options** page in this price list.
- C** Select fire code.
 - FR** - Compliance to TB 133
 - NFR** - Compliance to TB 117-2013
 See Upholstery Information for TB133 upcharge.
- D** Select poly seat and back color. Refer to the **Product Color Options** page in this price list.
- E** Select caster/glide option.
 - C** - Carpet casters
 - S** - Hard floor casters
 - GL** - Glides
 - SCG** - Front hard floor casters, rear glides
 - CCG** - Front carpet casters, rear glides
- F** Select upholstery grade/color. Refer to ki.com/fabrics

UPHOLSTERY INFORMATION

C.O.M. Upholstery
 C.O.M. requirement for 10 chairs or less with upholstered seat or upholstered seat and back is 3/4 yard per chair of 54" wide nondirectional fabric. For orders of 11 or more with upholstered seat and back and for complete information on ordering C.O.M. see "Ordering C.O.M., C.O.V. and C.O.L." section.

California TB133 Fire Safety Code
 For California Technical Bulletin 133 compliant models, add the following upcharge:
 Model=Polypropylene
 Added List Price=\$13
 Model=Upholstered Seat
 Added List Price=\$78

FINISH INFORMATION

Poly Bookbag Rack comes standard in Black. Other KI standard poly colors are available through a Product Modification Request. No upcharge or fees apply for orders of 20 or more. A net setup fee applies for orders of 19 or less. Please allow up 1 week additional leadtime.

SPECIAL SERVICES

Special Carton Marking

With specially marked information N/C

Shipping
 Ships assembled, FOB Green Bay, WI 54302, freight excluded. Freight class 300.

Specifications and prices are subject to change without prior notice.



Learn2® Classroom Furniture (Freight Excluded)

Strive® Seating without Worksurface



Learn2® Classroom Furniture (Freight Excluded)

Strive® Seating without Worksurface

| MODEL | Features | MODEL NUMBER | | | | | | Approx. Packaged Weight | Freight Excluded Pricing | Freight Excluded Pricing Fabric Grade 1, C.O.M. & COV | Freight Excluded Pricing Fabric Grade 2 | Freight Excluded Pricing Fabric Grade 3 & Group 2V Vinyl | Freight Excluded Pricing Pallas Fabric Group P0 | Freight Excluded Pricing Pallas Fabric Group P1 | Freight Excluded Pricing Pallas Fabric Group P2 | Freight Excluded Pricing Pallas Fabric Group P3 | Freight Excluded Pricing Pallas Fabric Group P4 |
|---------------------------------------------------------------------------------------------------------------------------------------------------------------------------------------------------------------|------------------|---------------|--------------------------|--------------------------|--------------------------|--------------------------|------------------|-------------------------|--------------------------|-------------------------------------------------------|-----------------------------------------|----------------------------------------------------------|-------------------------------------------------|-------------------------------------------------|-------------------------------------------------|-------------------------------------------------|-------------------------------------------------|
| | | Basic Model | Frame Color | Fire Code | Shell Color | Glide Option | Upholstery Color | | | | | | | | | | |
|  No Worksurface - Armchair without Accessory Rack | Polypropylene | L2SNP/CA/NAR | <input type="checkbox"/> | <input type="checkbox"/> | <input type="checkbox"/> | <input type="checkbox"/> | 47.0# | \$ 699 | | | | | | | | | |
| | Upholstered Seat | L2SNUS/CA/NAR | <input type="checkbox"/> | <input type="checkbox"/> | <input type="checkbox"/> | <input type="checkbox"/> | 50.0# | N/A | 765 | 798 | 813 | 819 | 865 | 873 | 898 | 917 | |
| 2SNSP 2SNSU | | | | | | | | | | | | | | | | | |
|  No Worksurface - Armchair with Accessory Rack • Accessory rack included on both sides of frame | Polypropylene | L2SNP/CA/SAR | <input type="checkbox"/> | <input type="checkbox"/> | <input type="checkbox"/> | <input type="checkbox"/> | 56.0# | \$ 724 | | | | | | | | | |
| | Upholstered Seat | L2SNUS/CA/SAR | <input type="checkbox"/> | <input type="checkbox"/> | <input type="checkbox"/> | <input type="checkbox"/> | 59.0# | N/A | 793 | 825 | 838 | 831 | 880 | 900 | 926 | 945 | |
| 2SNSP 2SNSU | | | | | | | | | | | | | | | | | |
|  No Worksurface - Armchair with Cup Holder/Accessory Rack • Cup holder/accessory rack included on both sides of frame | Polypropylene | L2SNP/CA/CAR | <input type="checkbox"/> | <input type="checkbox"/> | <input type="checkbox"/> | <input type="checkbox"/> | 56.0# | \$ 766 | | | | | | | | | |
| | Upholstered Seat | L2SNUS/CA/CAR | <input type="checkbox"/> | <input type="checkbox"/> | <input type="checkbox"/> | <input type="checkbox"/> | 59.0# | N/A | 837 | 867 | 883 | 875 | 923 | 945 | 969 | 987 | |
| 2SNSP 2SNSU | | | | | | | | | | | | | | | | | |

A **B** **C** **D** **E** **F**

HOW TO ORDER

- Indicate the following information on order form:
- Quantity of each item.
 - Model number, including options. See "How To Build a Model Number".
 - Any special service required.

Note: • The indicates that a choice is required.
 • The absence of the indicates that no choice is required.
 • Alpha-numeric characters in place of indicate that no other alternatives are available.

HOW TO BUILD A MODEL NUMBER

- A** Select basic model.
- B** Select frame color.
Refer to the **Product Color Options** page in this price list.
- C** Select fire code.

| | |
|------------|-----------------------------|
| NFR | - Compliance to TB 117-2013 |
| FR | - Compliance to TB 133 |

 See Upholstery Information for TB133 upcharge.
- D** Select poly seat and back color.
Refer to the **Product Color Options** page in this price list.
- E** Select caster/glide option.

| | |
|------------|-----------------------------------------|
| C | - Carpet casters |
| S | - Hard floor casters |
| GL | - Glides |
| SCG | - Front hard floor casters, rear glides |
| CCG | - Front carpet casters, rear glides |

F Select upholstery grade/color.
Refer to ki.com/fabrics

UPHOLSTERY INFORMATION

C.O.M. Upholstery

C.O.M. requirement for 10 chairs or less with upholstered seat or upholstered seat and back is 3/4 yard per chair of 54" wide nondirectional fabric. For orders of 11 or more with upholstered seat and back and for complete information on ordering C.O.M. see "Ordering C.O.M., C.O.V. and C.O.L." section.

California TB133 Fire Safety Code

For California Technical Bulletin 133 compliant models, add the following upcharge:
 Model=Polypropylene
 Added List Price=\$13
 Model=Upholstered Seat
 Added List Price=\$78

SPECIAL SERVICES

Special Carton Marking

With specially marked information N/C

Shipping

Ships assembled, FOB Green Bay, WI 54302, freight excluded. Freight class 300.

Specifications and prices are subject to change without prior notice.



Learn2® Classroom Furniture (Freight Excluded)

Strive® Seating without Worksurface



Learn2® Classroom Furniture (Freight Excluded)

Strive® Seating without Worksurface

| MODEL | Features | MODEL NUMBER | | | | | | Approx. Packaged Weight | Freight Excluded Pricing | Freight Excluded Pricing Fabric Grade 1, C.O.M. & COV | Freight Excluded Pricing Fabric Grade 2 | Freight Excluded Pricing Fabric Grade 3 & Group 2V Vinyl | Freight Excluded Pricing Pallas Fabric Group P0 | Freight Excluded Pricing Pallas Fabric Group P1 | Freight Excluded Pricing Pallas Fabric Group P2 | Freight Excluded Pricing Pallas Fabric Group P3 | Freight Excluded Pricing Pallas Fabric Group P4 |
|-------------------------------------------------------------------------------------------------------------------------------------------------------------------------------------------------------------------------------------------------------------------------------------------------------------------------------------------------------------------|------------------|---------------|--------------------------|--------------------------|--------------------------|--------------------------|------------------|-------------------------|--------------------------|-------------------------------------------------------|-----------------------------------------|----------------------------------------------------------|-------------------------------------------------|-------------------------------------------------|-------------------------------------------------|-------------------------------------------------|-------------------------------------------------|
| | | Basic Model | Frame Color | Fire Code | Shell Color | Glide Option | Upholstery Color | | | | | | | | | | |
|  <p>No Worksurface - Armchair with Poly Bookbag Rack</p> <ul style="list-style-type: none"> • Poly bookbag rack included • Poly bookbag rack includes two accessory slots and a cupholder • Poly Bookbag rack is only available in black | Polypropylene | L2SNP/CA/PBR | <input type="checkbox"/> | <input type="checkbox"/> | <input type="checkbox"/> | <input type="checkbox"/> | 56.0# | \$ 748 | | | | | | | | | |
| | Upholstered Seat | L2SNUS/CA/PBR | <input type="checkbox"/> | <input type="checkbox"/> | <input type="checkbox"/> | <input type="checkbox"/> | 59.0# | N/A | 814 | 846 | 862 | 868 | 913 | 922 | 947 | 966 | |
| 2SNSP | | | | | | | | | | | | | | | | | |
| 2SNSU | | | | | | | | | | | | | | | | | |
|  <p>No Worksurface - Armchair with Flat Accessory Rack</p> <ul style="list-style-type: none"> • Flat accessory rack included | Polypropylene | L2SNP/CA/FBR | <input type="checkbox"/> | <input type="checkbox"/> | <input type="checkbox"/> | <input type="checkbox"/> | 56.0# | \$ 766 | | | | | | | | | |
| | Upholstered Seat | L2SNUS/CA/FBR | <input type="checkbox"/> | <input type="checkbox"/> | <input type="checkbox"/> | <input type="checkbox"/> | 59.0# | N/A | 837 | 867 | 883 | 875 | 923 | 945 | 969 | 987 | |
| 2SNSP | | | | | | | | | | | | | | | | | |
| 2SNSU | | | | | | | | | | | | | | | | | |

A **B** **C** **D** **E** **F**

HOW TO ORDER

- Indicate the following information on order form:
- Quantity of each item.
 - Model number, including options. See "How To Build a Model Number".
 - Any special service required.

Note: • The indicates that a choice is required.
 • The absence of the indicates that no choice is required.
 • Alpha-numeric characters in place of indicate that no other alternatives are available.

HOW TO BUILD A MODEL NUMBER

- A** Select basic model.
- B** Select frame color. Refer to the **Product Color Options** page in this price list.
- C** Select fire code.
 - FR** - Compliance to TB 133
 - NFR** - Compliance to TB 117-2013
 See Upholstery Information for TB133 upcharge.
- D** Select poly seat and back color. Refer to the **Product Color Options** page in this price list.
- E** Select caster/glide option.
 - C** - Carpet casters
 - S** - Hard floor casters
 - GL** - Glides
 - SCG** - Front hard floor casters, rear glides
 - CCG** - Front carpet casters, rear glides
- F** Select upholstery grade/color. Refer to ki.com/fabrics

UPHOLSTERY INFORMATION

C.O.M. Upholstery
 C.O.M. requirement for 10 chairs or less with upholstered seat or upholstered seat and back is 3/4 yard per chair of 54" wide nondirectional fabric. For orders of 11 or more with upholstered seat and back and for complete information on ordering C.O.M. see "Ordering C.O.M., C.O.V. and C.O.L." section.

California TB133 Fire Safety Code
 For California Technical Bulletin 133 compliant models, add the following upcharge:
 Model=Polypropylene
 Added List Price=\$13
 Model=Upholstered Seat
 Added List Price=\$78

FINISH INFORMATION

Poly Bookbag Rack comes standard in Black. Other KI standard poly colors are available through a Product Modification Request. No upcharge or fees apply for orders of 20 or more. A net setup fee applies for orders of 19 or less. Please allow up 1 week additional leadtime.



SPECIAL SERVICES

Special Carton Marking
 With specially marked information N/C

Shipping
 Ships **assembled, FOB Green Bay, WI 54302, freight excluded.** Freight class 300.

Specifications and prices are subject to change without prior notice.



| Features | MODEL NUMBER | | | | | | | | | | Approx. Packaged Weight | Delivered Pricing Unupholstered | Delivered Pricing Fabric Grade 1, C.O.M. & COV | Delivered Pricing Fabric Grade 2 | Delivered Pricing Fabric Grade 3 & Group 2V Vinyl | Delivered Pricing Pallas Fabric Group P0 | Delivered Pricing Pallas Fabric Group P1 | Delivered Pricing Pallas Fabric Group P2 | Delivered Pricing Pallas Fabric Group P3 | Delivered Pricing Pallas Fabric Group P4 | |
|---------------------------------------------------------------------------------------------------------------------------------------------------------------------------------------------------------------------------------------------------------------------------------------------------------------------------------------------------------------------------------------------------------------------------------------------------------|-------------------------------|--------------|--------------------------|--------------------------|--------------------------|---------------------------|------------------------------|--------------------------|--------------------------|--------------------------|-------------------------|---------------------------------|------------------------------------------------|----------------------------------|---------------------------------------------------|------------------------------------------|------------------------------------------|------------------------------------------|------------------------------------------|------------------------------------------|--|
| | Basic Model | Surface Type | Frame Color | Fire Code | Poly Solid Color | Poly Outside/Inside Color | Surface Finish/Plastic Color | Glide Option | Uph. Color | | | | | | | | | | | | |
|  <p>2DWS1 2DWS2 2DWSA 2DWSB</p> <p>Without Accessory Rack</p> <ul style="list-style-type: none"> • Non-handed worksurface in choice of plastic or laminate • Solid or two-tone colored shell • Unlimited color match's • 17 degrees of hip articulation | Solid Color, Polypropylene | L2DT1/NAR | <input type="checkbox"/> | <input type="checkbox"/> | <input type="checkbox"/> | <input type="checkbox"/> | | <input type="checkbox"/> | <input type="checkbox"/> | | 57.0# | \$ 898 | | | | | | | | | |
| | Solid Color, Upholstered Seat | L2DT2/NAR | <input type="checkbox"/> | <input type="checkbox"/> | <input type="checkbox"/> | <input type="checkbox"/> | | <input type="checkbox"/> | <input type="checkbox"/> | <input type="checkbox"/> | 57.0# | N/A | 1048 | 1060 | 1081 | 1091 | 1142 | 1162 | 1187 | 1223 | |
| | Two-Tone, Polypropylene | L2DTA/NAR | <input type="checkbox"/> | <input type="checkbox"/> | NFR | | <input type="checkbox"/> | <input type="checkbox"/> | <input type="checkbox"/> | | 57.0# | 969 | | | | | | | | | |
| | Two-Tone, Upholstered Seat | L2DTB/NAR | <input type="checkbox"/> | <input type="checkbox"/> | NFR | | <input type="checkbox"/> | <input type="checkbox"/> | <input type="checkbox"/> | <input type="checkbox"/> | 57.0# | N/A | 1119 | 1129 | 1151 | 1162 | 1213 | 1233 | 1259 | 1294 | |
|  <p>2DWS1 2DWS2 2DWSA 2DWSB</p> <p>Accessory Rack</p> <ul style="list-style-type: none"> • Non-handed worksurface in choice of plastic or laminate • Accessory rack included on both sides of frame • Solid or two-tone colored shell • Unlimited color match's • 17 degrees of hip articulation | Solid Color, Polypropylene | L2DT1/SAR | <input type="checkbox"/> | <input type="checkbox"/> | <input type="checkbox"/> | <input type="checkbox"/> | | <input type="checkbox"/> | <input type="checkbox"/> | | 57.0# | \$ 929 | | | | | | | | | |
| | Solid Color, Upholstered Seat | L2DT2/SAR | <input type="checkbox"/> | <input type="checkbox"/> | <input type="checkbox"/> | <input type="checkbox"/> | | <input type="checkbox"/> | <input type="checkbox"/> | <input type="checkbox"/> | 57.0# | N/A | 1078 | 1089 | 1111 | 1121 | 1171 | 1191 | 1218 | 1253 | |
| | Two-Tone, Polypropylene | L2DTA/SAR | <input type="checkbox"/> | <input type="checkbox"/> | NFR | | <input type="checkbox"/> | <input type="checkbox"/> | <input type="checkbox"/> | | 57.0# | 998 | | | | | | | | | |
| | Two-Tone, Upholstered Seat | L2DTB/SAR | <input type="checkbox"/> | <input type="checkbox"/> | NFR | | <input type="checkbox"/> | <input type="checkbox"/> | <input type="checkbox"/> | <input type="checkbox"/> | 57.0# | N/A | 1147 | 1160 | 1180 | 1191 | 1242 | 1262 | 1288 | 1323 | |

HOW TO ORDER

- Indicate the following information on order form:
- Quantity of each item.
 - Model number, including options. See "How To Build a Model Number".
 - Any special service required.

Note: • The indicates that a choice is required.
 • The absence of the indicates that no choice is required.
 • Alpha-numeric characters in place of indicate that no other alternatives are available.

HOW TO BUILD A MODEL NUMBER

- A** Select basic model.
- B** Select worksurface type.
 LW - Laminate worksurface; add \$65
 PW - Plastic worksurface
- C** Select frame color.
 Refer to the **Product Color Options** page in this price list.
- D** Select fire code.
 NFR - Compliance to TB 117-2013
 FR - Compliance to TB 133
- E** Select solid poly color.
 Refer to the **Product Color Options** page in this price list.
- F** Select outside/inside poly color.
 Refer to the **Product Color Options** page in this price list.
- G** Select surface finish.

Refer to the **Product Color Options** page in this price list.

- H** Select caster/glide option.
 C - Carpet casters
 S - Hard floor casters
 GL - Glides
 SCG - Front hard floor casters, rear glides
 CCG - Front carpet casters, rear glides

I Select upholstery grade/color.
 Refer to ki.com/fabrics

UPHOLSTERY INFORMATION

C.O.M. Upholstery
 C.O.M. requirement for 10 chairs or less with upholstered seat or upholstered seat and back is 3/4 yard per chair of 54" wide nondirectional fabric. For orders of 11 or more with upholstered seat and back and for complete information on ordering C.O.M. see "Ordering C.O.M., C.O.V. and C.O.L." section.

California TB133 Fire Safety Code
 For California Technical Bulletin 133 compliant models, add the following upcharge:
 Model=Solid Color, Polypropylene
 Added List Price=\$13
 Model=Solid Color, Upholstered Seat
 Added List Price=\$90

SPECIAL SERVICES

Special Carton Marking
 With specially marked information N/C

Shipping
 Ships assembled, FOB Green Bay, WI 54302, freight prepaid. Freight class 300.

Specifications and prices are subject to change without prior notice.



| Features | MODEL NUMBER | | | | | | | | | | Approx. Packaged Weight | Delivered Pricing Unupholstered | Delivered Pricing Fabric Grade 1, C.O.M. & COV | Delivered Pricing Fabric Grade 2 | Delivered Pricing Fabric Grade 3 & Group 2V Vinyl | Delivered Pricing Pallas Fabric Group P0 | Delivered Pricing Pallas Fabric Group P1 | Delivered Pricing Pallas Fabric Group P2 | Delivered Pricing Pallas Fabric Group P3 | Delivered Pricing Pallas Fabric Group P4 | | |
|-------------------------------|--------------|--------------------------|--------------------------|--------------------------|--------------------------|---------------------------|------------------------------|--------------------------|--------------------------|--|-------------------------|---------------------------------|------------------------------------------------|----------------------------------|---------------------------------------------------|------------------------------------------|------------------------------------------|------------------------------------------|------------------------------------------|------------------------------------------|--|--|
| | Basic Model | Surface Type | Frame Color | Fire Code | Poly Solid Color | Poly Outside/Inside Color | Surface Finish/Plastic Color | Glide Option | Uph. Color | | | | | | | | | | | | | |
| Solid Color, Polypropylene | L2DT1/CAR | <input type="checkbox"/> | <input type="checkbox"/> | <input type="checkbox"/> | <input type="checkbox"/> | | <input type="checkbox"/> | <input type="checkbox"/> | | | 57.0# | \$ 977 | | | | | | | | | | |
| Solid Color, Upholstered Seat | L2DT2/CAR | <input type="checkbox"/> | <input type="checkbox"/> | <input type="checkbox"/> | <input type="checkbox"/> | | <input type="checkbox"/> | <input type="checkbox"/> | <input type="checkbox"/> | | 57.0# | N/A | 1126 | 1137 | 1159 | 1169 | 1220 | 1240 | 1264 | 1301 | | |
| Two-Tone, Polypropylene | L2DTA/CAR | <input type="checkbox"/> | <input type="checkbox"/> | NFR | | <input type="checkbox"/> | <input type="checkbox"/> | <input type="checkbox"/> | | | 57.0# | 1047 | | | | | | | | | | |
| Two-Tone, Upholstered Seat | L2DTB/CAR | <input type="checkbox"/> | <input type="checkbox"/> | NFR | | <input type="checkbox"/> | <input type="checkbox"/> | <input type="checkbox"/> | <input type="checkbox"/> | | 57.0# | N/A | 1195 | 1209 | 1227 | 1240 | 1290 | 1312 | 1334 | 1372 | | |
| | | | | | | | | | | | | | | | | | | | | | | |
| | | | | | | | | | | | | | | | | | | | | | | |
| | | | | | | | | | | | | | | | | | | | | | | |
| | | | | | | | | | | | | | | | | | | | | | | |
| | | | | | | | | | | | | | | | | | | | | | | |
| | | | | | | | | | | | | | | | | | | | | | | |
| | | | | | | | | | | | | | | | | | | | | | | |
| | | | | | | | | | | | | | | | | | | | | | | |
| | | | | | | | | | | | | | | | | | | | | | | |
| | A | B | C | D | E | F | G | H | I | | | | | | | | | | | | | |



2DWS1
2DWS2
2DWSA
2DWSB

- Cup Holder/Accessory Rack**
- Non-handed worksurface in choice of plastic or laminate
 - Cup holder/accessory rack included on both sides of frame
 - Solid or two-tone colored shell
 - Unlimited color match's
 - 17 degrees of hip articulation

HOW TO ORDER

Indicate the following information on order form:

1. Quantity of each item.
2. Model number, including options. See "How To Build a Model Number".
3. Any special service required.

Note: • The indicates that a choice is required.

- The absence of the indicates that no choice is required.
- Alpha-numeric characters in place of indicate that no other alternatives are available.

HOW TO BUILD A MODEL NUMBER

A Select basic model.

B Select worksurface type.
LW - Laminate worksurface; add \$65
PW - Plastic worksurface

C Select frame color.
 Refer to the **Product Color Options** page in this price list.

D Select fire code.
NFR - Compliance to TB 117-2013
FR - Compliance to TB 133

E Select solid poly color.
 Refer to the **Product Color Options** page in this price list.

F Select outside/inside poly color.
 Refer to the **Product Color Options** page in this price list.

G Select surface finish.

H Select caster/glide option.
C - Carpet casters
S - Hard floor casters
GL - Glides
SCG - Front hard floor casters, rear glides
CCG - Front carpet casters, rear glides

I Select upholstery grade/color.
 Refer to ki.com/fabrics

Refer to the **Product Color Options** page in this price list.

UPHOLSTERY INFORMATION

C.O.M. Upholstery
 C.O.M. requirement for 10 chairs or less with upholstered seat or upholstered seat and back is 3/4 yard per chair of 54" wide nondirectional fabric. For orders of 11 or more with upholstered seat and back and for complete information on ordering C.O.M. see "Ordering C.O.M., C.O.V. and C.O.L." section.

California TB133 Fire Safety Code
 For California Technical Bulletin 133 compliant models, add the following upcharge:
 Model=Solid Color, Polypropylene
 Added List Price=\$13
 Model=Solid Color, Upholstered Seat
 Added List Price=\$90

SPECIAL SERVICES

Special Carton Marking
 With specially marked information N/C

Shipping
 Ships assembled, FOB Green Bay, WI 54302, freight prepaid. Freight class 300.

Specifications and prices are subject to change without prior notice.

Learn2® Classroom Furniture (Delivered)

Doni® Seating with Worksurface



Learn2® Classroom Furniture (Delivered)

Doni® Seating with Worksurface

| Features | MODEL NUMBER | | | | | | | | | | Approx. Packaged Weight | Delivered Pricing Unupholstered | Delivered Pricing Fabric Grade 1, C.O.M. & COV | Delivered Pricing Fabric Grade 2 | Delivered Pricing Fabric Grade 3 & Group 2V Vinyl | Delivered Pricing Pallas Fabric Group P0 | Delivered Pricing Pallas Fabric Group P1 | Delivered Pricing Pallas Fabric Group P2 | Delivered Pricing Pallas Fabric Group P3 | Delivered Pricing Pallas Fabric Group P4 |
|-------------------------------|--------------|--------------------------|--------------------------|--------------------------|--------------------------|---------------------------|------------------------------|--------------------------|--------------------------|--------------------------|-------------------------|---------------------------------|------------------------------------------------|----------------------------------|---------------------------------------------------|------------------------------------------|------------------------------------------|------------------------------------------|------------------------------------------|------------------------------------------|
| | Basic Model | Surface Type | Frame Color | Fire Code | Poly Solid Color | Poly Outside/Inside Color | Surface Finish/Plastic Color | Glide Option | Uph. Color | | | | | | | | | | | |
| Solid Color, Polypropylene | L2DT1/PBR | <input type="checkbox"/> | <input type="checkbox"/> | <input type="checkbox"/> | <input type="checkbox"/> | | <input type="checkbox"/> | <input type="checkbox"/> | | | 57.0# | \$ 956 | | | | | | | | |
| Solid Color, Upholstered Seat | L2DT2/PBR | <input type="checkbox"/> | <input type="checkbox"/> | <input type="checkbox"/> | <input type="checkbox"/> | | <input type="checkbox"/> | <input type="checkbox"/> | <input type="checkbox"/> | <input type="checkbox"/> | 57.0# | N/A | 1106 | 1117 | 1139 | 1148 | 1199 | 1220 | 1244 | 1280 |
| Two-Tone, Polypropylene | L2DTA/PBR | <input type="checkbox"/> | <input type="checkbox"/> | NFR | | <input type="checkbox"/> | <input type="checkbox"/> | <input type="checkbox"/> | | | 57.0# | 1026 | | | | | | | | |
| Two-Tone, Upholstered Seat | L2DTB/PBR | <input type="checkbox"/> | <input type="checkbox"/> | NFR | | <input type="checkbox"/> | <input type="checkbox"/> | <input type="checkbox"/> | <input type="checkbox"/> | <input type="checkbox"/> | 57.0# | N/A | 1175 | 1187 | 1209 | 1220 | 1271 | 1290 | 1315 | 1352 |
| | | | | | | | | | | | | | | | | | | | | |
| | | | | | | | | | | | | | | | | | | | | |
| | | | | | | | | | | | | | | | | | | | | |
| | | | | | | | | | | | | | | | | | | | | |
| | | | | | | | | | | | | | | | | | | | | |
| | | | | | | | | | | | | | | | | | | | | |
| | | | | | | | | | | | | | | | | | | | | |
| | | | | | | | | | | | | | | | | | | | | |
| | | | | | | | | | | | | | | | | | | | | |
| | | | | | | | | | | | | | | | | | | | | |



2DWS1
2DWS2
2DWSA
2DWSB

- Poly Bookbag Rack**
- Non-handed worksurface in choice of plastic or laminate
 - Poly bookbag rack included
 - Poly bookbag rack includes two accessory slots and a cupholder
 - Poly Bookbag rack is only available in black
 - Solid or two-tone colored shell
 - Unlimited color match's
 - 17 degrees of hip articulation

HOW TO ORDER

Indicate the following information on order form:

1. Quantity of each item.
2. Model number, including options. See "How To Build a Model Number".
3. Any special service required.

Note: • The indicates that a choice is required.
• The absence of the indicates that no choice is required.
• Alpha-numeric characters in place of indicate that no other alternatives are available.

HOW TO BUILD A MODEL NUMBER

A Select basic model.

B Select worksurface type.
 LW - Laminate worksurface; add \$65
 PW - Plastic worksurface

C Select frame color.
 Refer to the **Product Color Options** page in this price list.

D Select fire code.
 NFR - Compliance to TB 117-2013
 FR - Compliance to TB 133

E Select solid poly color.
 Refer to the **Product Color Options** page in this price list.

F Select outside/inside poly color.
 Refer to the **Product Color Options** page in this price list.

G Select surface finish.

H Select caster/glide option.
 C - Carpet casters
 S - Hard floor casters
 GL - Glides
 SCG - Front hard floor casters, rear glides
 CCG - Front carpet casters, rear glides

I Select upholstery grade/color.
 Refer to ki.com/fabrics

Refer to the **Product Color Options** page in this price list.

UPHOLSTERY INFORMATION

C.O.M. Upholstery
 C.O.M. requirement for 10 chairs or less with upholstered seat or upholstered seat and back is 3/4 yard per chair of 54" wide nondirectional fabric. For orders of 11 or more with upholstered seat and back and for complete information on ordering C.O.M. see "Ordering C.O.M., C.O.V. and C.O.L." section.

California TB133 Fire Safety Code
 For California Technical Bulletin 133 compliant models, add the following upcharge:
 Model=Solid Color, Polypropylene
 Added List Price=\$13
 Model=Solid Color, Upholstered Seat
 Added List Price=\$90

FINISH INFORMATION

Poly Bookbag Rack comes standard in Black. Other KI standard poly colors are available through a Product Modification Request. No upcharge or fees apply for orders of 20 or more. A net setup fee applies for orders of 19 or less. Please allow up 1 week additional leadtime.

SPECIAL SERVICES

Special Carton Marking
 With specially marked information N/C

Shipping
 Ships assembled, FOB Green Bay, WI 54302, freight prepaid. Freight class 300.

Specifications and prices are subject to change without prior notice.



| Features | MODEL NUMBER | | | | | | | | | | Approx. Packaged Weight | Delivered Pricing Unupholstered | Delivered Pricing Fabric Grade 1, C.O.M. & COV | Delivered Pricing Fabric Grade 2 | Delivered Pricing Fabric Grade 3 & Group 2V Vinyl | Delivered Pricing Pallas Fabric Group P0 | Delivered Pricing Pallas Fabric Group P1 | Delivered Pricing Pallas Fabric Group P2 | Delivered Pricing Pallas Fabric Group P3 | Delivered Pricing Pallas Fabric Group P4 | |
|-------------------------------|--------------|--------------------------|--------------------------|--------------------------|--------------------------|---------------------------|------------------------------|--------------------------|--------------------------|--------------------------|-------------------------|---------------------------------|------------------------------------------------|----------------------------------|---------------------------------------------------|------------------------------------------|------------------------------------------|------------------------------------------|------------------------------------------|------------------------------------------|--|
| | Basic Model | Surface Type | Frame Color | Fire Code | Poly Solid Color | Poly Outside/Inside Color | Surface Finish/Plastic Color | Glide Option | Uph. Color | | | | | | | | | | | | |
| Solid Color, Polypropylene | L2DT1/FBR | <input type="checkbox"/> | <input type="checkbox"/> | <input type="checkbox"/> | <input type="checkbox"/> | | <input type="checkbox"/> | <input type="checkbox"/> | <input type="checkbox"/> | | 57.0# | \$ 977 | | | | | | | | | |
| Solid Color, Upholstered Seat | L2DT2/FBR | <input type="checkbox"/> | <input type="checkbox"/> | <input type="checkbox"/> | <input type="checkbox"/> | | <input type="checkbox"/> | <input type="checkbox"/> | <input type="checkbox"/> | <input type="checkbox"/> | 57.0# | N/A | 1126 | 1137 | 1159 | 1169 | 1220 | 1240 | 1264 | 1301 | |
| Two-Tone, Polypropylene | L2DTA/FBR | <input type="checkbox"/> | <input type="checkbox"/> | NFR | | <input type="checkbox"/> | <input type="checkbox"/> | <input type="checkbox"/> | <input type="checkbox"/> | | 57.0# | 1047 | | | | | | | | | |
| Two-Tone, Upholstered Seat | L2DTB/FBR | <input type="checkbox"/> | <input type="checkbox"/> | NFR | | <input type="checkbox"/> | <input type="checkbox"/> | <input type="checkbox"/> | <input type="checkbox"/> | <input type="checkbox"/> | 57.0# | N/A | 1195 | 1209 | 1227 | 1240 | 1290 | 1312 | 1334 | 1372 | |
| | | | | | | | | | | | | | | | | | | | | | |
| | | | | | | | | | | | | | | | | | | | | | |
| | | | | | | | | | | | | | | | | | | | | | |
| | | | | | | | | | | | | | | | | | | | | | |
| | | | | | | | | | | | | | | | | | | | | | |
| | | | | | | | | | | | | | | | | | | | | | |
| | | | | | | | | | | | | | | | | | | | | | |



2DWS1
2DWS2
2DWSA
2DWSB

- Flat Accessory Rack**
- Non-handed worksurface in choice of plastic or laminate
 - Flat accessory rack included
 - Solid or two-tone colored shell
 - Unlimited color match's
 - 17 degrees of hip articulation

HOW TO ORDER

Indicate the following information on order form:
 1. Quantity of each item.
 2. Model number, including options. See "How To Build a Model Number".
 3. Any special service required.

Note: • The indicates that a choice is required.
 • The absence of the indicates that no choice is required.
 • Alpha-numeric characters in place of indicate that no other alternatives are available.

HOW TO BUILD A MODEL NUMBER

- A** Select basic model.
- B** Select worksurface type.

| | |
|-----------|----------------------------------|
| LW | - Laminate worksurface; add \$65 |
| PW | - Plastic worksurface |
- C** Select frame color.
Refer to the **Product Color Options** page in this price list.
- D** Select fire code.

| | |
|------------|-----------------------------|
| NFR | - Compliance to TB 117-2013 |
| FR | - Compliance to TB 133 |
- E** Select solid poly color.
Refer to the **Product Color Options** page in this price list.
- F** Select outside/inside poly color.
Refer to the **Product Color Options** page in this price list.
- G** Select surface finish.

- Refer to the **Product Color Options** page in this price list.
- H** Select caster/glide option.

| | |
|------------|-----------------------------------------|
| C | - Carpet casters |
| S | - Hard floor casters |
| GL | - Glides |
| SCG | - Front hard floor casters, rear glides |
| CCG | - Front carpet casters, rear glides |
 - I** Select upholstery grade/color.
Refer to ki.com/fabrics

UPHOLSTERY INFORMATION

C.O.M. Upholstery

C.O.M. requirement for 10 chairs or less with upholstered seat or upholstered seat and back is 3/4 yard per chair of 54" wide nondirectional fabric. For orders of 11 or more with upholstered seat and back and for complete information on ordering C.O.M. see "Ordering C.O.M., C.O.V. and C.O.L." section.

California TB133 Fire Safety Code

For California Technical Bulletin 133 compliant models, add the following upcharge:
 Model=Solid Color, Polypropylene
 Added List Price=\$13
 Model=Solid Color, Upholstered Seat
 Added List Price=\$90

SPECIAL SERVICES

Special Carton Marking

With specially marked information N/C

Shipping

Ships **assembled, FOB Green Bay, WI 54302, freight prepaid.** Freight class 300.

Specifications and prices are subject to change without prior notice.



Learn2® Classroom Furniture (Delivered)

Intellect Wave® Seating with Worksurface



Learn2® Classroom Furniture (Delivered)

Intellect Wave® Seating with Worksurface

| MODEL | Features | MODEL NUMBER | | | | | | | | | Approx. Packaged Weight | Delivered Pricing | Delivered Pricing Fabric Grade 1, C.O.M. & COV | Delivered Pricing Fabric Grade 2 | Delivered Pricing Fabric Grade 3 & Group 2V Vinyl | Delivered Pricing Pallas Fabric Group P0 | Delivered Pricing Pallas Fabric Group P1 | Delivered Pricing Pallas Fabric Group P2 | Delivered Pricing Pallas Fabric Group P3 | Delivered Pricing Pallas Fabric Group P4 | |
|-----------------------------------------------------------------------------------------------------|--------------------------------------------------------------------------------------------------------------------------------------------------------------|------------------|--------------|--------------------------|--------------------------|--------------------------|------------------------------|--------------------------|--------------------------|--------------------------|--------------------------|-------------------|------------------------------------------------|----------------------------------|---------------------------------------------------|------------------------------------------|------------------------------------------|------------------------------------------|------------------------------------------|------------------------------------------|-----|
| | | Basic Model | Surface Type | Frame Color | Fire Code | Shell Color | Surface Finish/Plastic Color | Glide Option | Uph. Color | | | | | | | | | | | | |
|  2WWSP 2WWSU | Without Accessory Rack • Non-handed worksurface in choice of plastic or laminate | Polypropylene | L2WTP/NAR | <input type="checkbox"/> | <input type="checkbox"/> | <input type="checkbox"/> | <input type="checkbox"/> | <input type="checkbox"/> | <input type="checkbox"/> | <input type="checkbox"/> | 37.0# | \$ 734 | | | | | | | | | |
| | | Upholstered Seat | L2WTUS/NAR | <input type="checkbox"/> | <input type="checkbox"/> | <input type="checkbox"/> | <input type="checkbox"/> | <input type="checkbox"/> | <input type="checkbox"/> | <input type="checkbox"/> | <input type="checkbox"/> | 40.0# | N/A | 806 | 811 | 823 | 811 | 861 | 881 | 900 | 919 |
|  2WWSP 2WWSU | Accessory Rack • Non-handed worksurface in choice of plastic or laminate • Accessory rack included on both sides of frame | Polypropylene | L2WTP/SAR | <input type="checkbox"/> | <input type="checkbox"/> | <input type="checkbox"/> | <input type="checkbox"/> | <input type="checkbox"/> | <input type="checkbox"/> | <input type="checkbox"/> | 46.0# | \$ 761 | | | | | | | | | |
| | | Upholstered Seat | L2WTUS/SAR | <input type="checkbox"/> | <input type="checkbox"/> | <input type="checkbox"/> | <input type="checkbox"/> | <input type="checkbox"/> | <input type="checkbox"/> | <input type="checkbox"/> | <input type="checkbox"/> | 49.0# | N/A | 834 | 838 | 852 | 838 | 890 | 908 | 930 | 947 |
|  2WWSP 2WWSU | Cup Holder/Accessory Rack • Non-handed worksurface in choice of plastic or laminate • Cup holder/accessory rack included on both sides of frame | Polypropylene | L2WTP/CAR | <input type="checkbox"/> | <input type="checkbox"/> | <input type="checkbox"/> | <input type="checkbox"/> | <input type="checkbox"/> | <input type="checkbox"/> | <input type="checkbox"/> | 46.0# | \$ 810 | | | | | | | | | |
| | | Upholstered Seat | L2WTUS/CAR | <input type="checkbox"/> | <input type="checkbox"/> | <input type="checkbox"/> | <input type="checkbox"/> | <input type="checkbox"/> | <input type="checkbox"/> | <input type="checkbox"/> | <input type="checkbox"/> | 49.0# | N/A | 884 | 888 | 899 | 888 | 938 | 956 | 979 | 995 |

A B C D E F G H

HOW TO ORDER

- Indicate the following information on order form:
- Quantity of each item.
 - Model number, including options. See "How To Build a Model Number".
 - Any special service required.

Note: • The indicates that a choice is required.
 • The absence of the indicates that no choice is required.
 • Alpha-numeric characters in place of indicate that no other alternatives are available.

HOW TO BUILD A MODEL NUMBER

- A** Select basic model.
- B** Select worksurface type.
 LW - Laminate worksurface; add \$65
 PW - Plastic worksurface
- C** Select frame color.
 Refer to the **Product Color Options** page in this price list.
- D** Select fire code.
 NFR - Compliance to TB 117-2013
 FR - Compliance to TB 133
 See Upholstery Information for TB133 upcharge.
- E** Select shell color.
 Refer to the **Product Color Options** page in this price list.
- F** Select surface finish.
 Refer to the **Product Color Options** page in this price list.

- G** Select caster/glide option.
 C - Carpet casters
 S - Hard floor casters
 GL - Glides
 SCG - Front hard floor casters, rear glides
 CCG - Front carpet casters, rear glides
- H** Select upholstery grade/color.
 Refer to ki.com/fabrics

UPHOLSTERY INFORMATION

C.O.M. Upholstery
 C.O.M. requirement is 5/8 yard per chair for seat of 54" wide nondirectional fabric. For complete information on ordering C.O.M. see "Ordering C.O.M., C.O.V. and C.O.L." section.

California TB133 Fire Safety Code
 For California Technical Bulletin 133 compliant models, add the following upcharge:
 Model=Polypropylene
 Added List Price=\$28
 Model=Upholstered Seat
 Added List Price=\$83



SPECIAL SERVICES

Special Carton Marking
 With specially marked information N/C

Shipping
 Ships assembled, FOB Green Bay, WI 54302, freight prepaid. Freight class 300.

Specifications and prices are subject to change without prior notice.



| MODEL | Features | MODEL NUMBER | | | | | | | | Approx. Packaged Weight | Delivered Pricing | Delivered Pricing Fabric Grade 1, C.O.M. & COV | Delivered Pricing Fabric Grade 2 | Delivered Pricing Fabric Grade 3 & Group 2V Vinyl | Delivered Pricing Pallas Fabric Group P0 | Delivered Pricing Pallas Fabric Group P1 | Delivered Pricing Pallas Fabric Group P2 | Delivered Pricing Pallas Fabric Group P3 | Delivered Pricing Pallas Fabric Group P4 | |
|----------------------------------------------------------------------------------------------------|---------------------------------------------------------------------------------------------------------------------------------------------------------------------------------------------------------------------------------------------|------------------|--------------|--------------------------|--------------------------|--------------------------|------------------------------|--------------------------|--------------------------|--------------------------|--------------------------|------------------------------------------------|----------------------------------|---------------------------------------------------|------------------------------------------|------------------------------------------|------------------------------------------|------------------------------------------|------------------------------------------|-----|
| | | Basic Model | Surface Type | Frame Color | Fire Code | Shell Color | Surface Finish/Plastic Color | Glide Option | Uph. Color | | | | | | | | | | | |
|  2WWSP 2WWSU | Poly Bookbag Rack • Non-handed worksurface in choice of plastic or laminate • Poly bookbag rack included • Poly bookbag rack includes two accessory slots and a cupholder • Poly Bookbag rack is only available in black | Polypropylene | L2WTP/PBR | <input type="checkbox"/> | <input type="checkbox"/> | <input type="checkbox"/> | <input type="checkbox"/> | <input type="checkbox"/> | <input type="checkbox"/> | <input type="checkbox"/> | 46.0# | \$ 790 | | | | | | | | |
| | | Upholstered Seat | L2WTUS/PBR | <input type="checkbox"/> | <input type="checkbox"/> | <input type="checkbox"/> | <input type="checkbox"/> | <input type="checkbox"/> | <input type="checkbox"/> | <input type="checkbox"/> | <input type="checkbox"/> | 49.0# | N/A | 862 | 869 | 881 | 869 | 918 | 938 | 958 |
|  2WWSP 2WWSU | Flat Accessory Rack • Non-handed worksurface in choice of plastic or laminate • Flat accessory rack included | Polypropylene | L2WTP/FBR | <input type="checkbox"/> | <input type="checkbox"/> | <input type="checkbox"/> | <input type="checkbox"/> | <input type="checkbox"/> | <input type="checkbox"/> | <input type="checkbox"/> | 46.0# | \$ 810 | | | | | | | | |
| | | Upholstered Seat | L2WTUS/FBR | <input type="checkbox"/> | <input type="checkbox"/> | <input type="checkbox"/> | <input type="checkbox"/> | <input type="checkbox"/> | <input type="checkbox"/> | <input type="checkbox"/> | <input type="checkbox"/> | 49.0# | N/A | 884 | 888 | 899 | 888 | 938 | 956 | 979 |

A **B** **C** **D** **E** **F** **G** **H**

HOW TO ORDER

- Indicate the following information on order form:
- Quantity of each item.
 - Model number, including options. See "How To Build a Model Number".
 - Any special service required.

Note: • The indicates that a choice is required.
 • The absence of the indicates that no choice is required.
 • Alpha-numeric characters in place of indicate that no other alternatives are available.

HOW TO BUILD A MODEL NUMBER

- A** Select basic model.
- B** Select worksurface type.
 - LW** - Laminate worksurface; add \$65
 - PW** - Plastic worksurface
- C** Select frame color. Refer to the **Product Color Options** page in this price list.
- D** Select fire code.
 - FR** - Compliance to TB 133
 - NFR** - Compliance to TB 117-2013
 See Upholstery Information for TB133 upcharge.
- E** Select shell color. Refer to the **Product Color Options** page in this price list.
- F** Select surface finish. Refer to the **Product Color Options** page in this price list.
- G** Select caster/glide option.
 - C** - Carpet casters
 - S** - Hard floor casters
 - GL** - Glides
 - SCG** - Front hard floor casters, rear glides
 - CCG** - Front carpet casters, rear glides
- H** Select upholstery grade/color. Refer to ki.com/fabrics

UPHOLSTERY INFORMATION

C.O.M. Upholstery
 C.O.M. requirement is 5/8 yard per chair for seat of 54" wide nondirectional fabric. For complete information on ordering C.O.M. see "Ordering C.O.M., C.O.V. and C.O.L." section.

California TB133 Fire Safety Code
 For California Technical Bulletin 133 compliant models, add the following upcharge:
 Model=Polypropylene
 Added List Price=\$28
 Model=Upholstered Seat
 Added List Price=\$83

FINISH INFORMATION

Poly Bookbag Rack comes standard in Black. Other KI standard poly colors are available through a Product Modification Request. No upcharge or fees apply for orders of 20 or more. A net setup fee applies for orders of 19 or less. Please allow up 1 week additional leadtime.



SPECIAL SERVICES

Special Carton Marking
 With specially marked information N/C

Shipping
 Ships **assembled, FOB Green Bay, WI 54302, freight prepaid.** Freight class 300.

Specifications and prices are subject to change without prior notice.



| MODEL | Features | MODEL NUMBER | | | | | | | | Approx. Packaged Weight | Delivered Pricing | Delivered Pricing Fabric Grade 1, C.O.M. & COV | Delivered Pricing Fabric Grade 2 | Delivered Pricing Fabric Grade 3 & Group 2V Vinyl | Delivered Pricing Pallas Fabric Group P0 | Delivered Pricing Pallas Fabric Group P1 | Delivered Pricing Pallas Fabric Group P2 | Delivered Pricing Pallas Fabric Group P3 | Delivered Pricing Pallas Fabric Group P4 |
|----------------------------------------------------------------------------------------------------------------------------------------------------------------------------------------------------------------------------------------------------------------------------------------|------------------|--------------|--------------------------|--------------------------|--------------------------|--------------------------|------------------------------|--------------------------|--------------------------|-------------------------|-------------------|------------------------------------------------|----------------------------------|---------------------------------------------------|------------------------------------------|------------------------------------------|------------------------------------------|------------------------------------------|------------------------------------------|
| | | Basic Model | Surface Type | Frame Color | Fire Code | Shell Color | Surface Finish/Plastic Color | Glide Option | Uph. Color | | | | | | | | | | |
|  Without Accessory Rack • One-piece shell • Passive back flex • Non-handed worksurface in choice of plastic or laminate | Polypropylene | L2LT1/NA/NAR | <input type="checkbox"/> | <input type="checkbox"/> | <input type="checkbox"/> | <input type="checkbox"/> | <input type="checkbox"/> | <input type="checkbox"/> | <input type="checkbox"/> | 47.0# | \$ 876 | | | | | | | | |
| | Upholstered Seat | L2LT2/NA/NAR | <input type="checkbox"/> | <input type="checkbox"/> | <input type="checkbox"/> | <input type="checkbox"/> | <input type="checkbox"/> | <input type="checkbox"/> | <input type="checkbox"/> | 49.0# | N/A | 952 | 985 | 1002 | 993 | 1045 | 1068 | 1095 | 1117 |
| 2LWS1 2LWS2 | | | | | | | | | | | | | | | | | | | |
|  Accessory Rack • One-piece shell • Passive back flex • Non-handed worksurface in choice of plastic or laminate • Accessory rack included on both sides of frame | Polypropylene | L2LT1/NA/SAR | <input type="checkbox"/> | <input type="checkbox"/> | <input type="checkbox"/> | <input type="checkbox"/> | <input type="checkbox"/> | <input type="checkbox"/> | <input type="checkbox"/> | 55.0# | \$ 905 | | | | | | | | |
| | Upholstered Seat | L2LT2/NA/SAR | <input type="checkbox"/> | <input type="checkbox"/> | <input type="checkbox"/> | <input type="checkbox"/> | <input type="checkbox"/> | <input type="checkbox"/> | <input type="checkbox"/> | 57.0# | N/A | 982 | 1015 | 1032 | 1023 | 1075 | 1098 | 1125 | 1147 |
| 2LWS1 2LWS2 | | | | | | | | | | | | | | | | | | | |
|  Cup Holder/Accessory Rack • One-piece shell • Passive back flex • Non-handed worksurface in choice of plastic or laminate • Cup holder/accessory rack included on both sides of frame | Polypropylene | L2LT1/NA/CAR | <input type="checkbox"/> | <input type="checkbox"/> | <input type="checkbox"/> | <input type="checkbox"/> | <input type="checkbox"/> | <input type="checkbox"/> | <input type="checkbox"/> | 55.0# | \$ 953 | | | | | | | | |
| | Upholstered Seat | L2LT2/NA/CAR | <input type="checkbox"/> | <input type="checkbox"/> | <input type="checkbox"/> | <input type="checkbox"/> | <input type="checkbox"/> | <input type="checkbox"/> | <input type="checkbox"/> | 57.0# | N/A | 1028 | 1061 | 1078 | 1069 | 1121 | 1144 | 1171 | 1193 |
| 2LWS1 2LWS2 | | | | | | | | | | | | | | | | | | | |

A **B** **C** **D** **E** **F** **G** **H**

HOW TO ORDER

- Indicate the following information on order form:
- Quantity of each item.
 - Model number, including options. See "How To Build a Model Number".
 - Any special service required.

Note: • The indicates that a choice is required.
 • The absence of the indicates that no choice is required.
 • Alpha-numeric characters in place of indicate that no other alternatives are available.

HOW TO BUILD A MODEL NUMBER

- A** Select basic model.
- B** Select worksurface type.
 LW - Laminate worksurface
 PW - Plastic worksurface
- C** Select frame color.
 Refer to the **Product Color Options** page in this price list.
- D** Select fire code.
 NFR - Compliance to TB 117-2013
 FR - Compliance to TB 133
 See Upholstery Information for TB133 upcharge.
- E** Select poly seat and back color.
 Refer to the **Product Color Options** page in this price list.
- F** Select surface finish.
 Refer to the **Product Color Options** page in this price list.

- G** Select caster/glide option.
 C - Carpet casters
 S - Hard floor casters
 GL - Glides
 SCG - Front hard floor casters, rear glides
 CCG - Front carpet casters, rear glides
- H** Select upholstery grade/color.
 Refer to ki.com/fabrics

UPHOLSTERY INFORMATION

C.O.M. Upholstery
 C.O.M. requirement for 10 chairs or less with upholstered seat or upholstered seat and back is 3/4 yard per chair of 54" wide nondirectional fabric. For orders of 11 or more with upholstered seat and back and for complete information on ordering C.O.M. see "Ordering C.O.M., C.O.V. and C.O.L." section.

California TB133 Fire Safety Code
 For California Technical Bulletin 133 compliant models, add the following upcharge:
 Model=Polypropylene
 Added List Price=\$13
 Model=Upholstered Seat
 Added List Price=\$85



SPECIAL SERVICES

Special Carton Marking
 With specially marked information N/C

Shipping
 Ships assembled, FOB Green Bay, WI 54302, freight prepaid. Freight class 300.

Specifications and prices are subject to change without prior notice.



| MODEL | Features | MODEL NUMBER | | | | | | | | Approx. Packaged Weight | Delivered Pricing | Delivered Pricing Fabric Grade 1, C.O.M. & COV | Delivered Pricing Fabric Grade 2 | Delivered Pricing Fabric Grade 3 & Group 2V Vinyl | Delivered Pricing Pallas Fabric Group P0 | Delivered Pricing Pallas Fabric Group P1 | Delivered Pricing Pallas Fabric Group P2 | Delivered Pricing Pallas Fabric Group P3 | Delivered Pricing Pallas Fabric Group P4 | |
|-----------------------------------------------------------------------------------------------------|-----------------------------------------------------------------------------------------------------------------------------------------------------------------------------------------------------------------------------------------------------------------------------------------|------------------|--------------|--------------------------|--------------------------|--------------------------|------------------------------|--------------------------|--------------------------|--------------------------|--------------------------|------------------------------------------------|----------------------------------|---------------------------------------------------|------------------------------------------|------------------------------------------|------------------------------------------|------------------------------------------|------------------------------------------|------|
| | | Basic Model | Surface Type | Frame Color | Fire Code | Shell Color | Surface Finish/Plastic Color | Glide Option | Uph. Color | | | | | | | | | | | |
|  2LWS1 2LWS2 | Poly Bookbag Rack • One-piece shell • Passive back flex • Non-handed worksurface in choice of plastic or laminate • Poly bookbag rack included • Poly bookbag rack includes two accessory slots and a cupholder • Poly Bookbag rack is only available in black | Polypropylene | L2LT1/NA/PBR | <input type="checkbox"/> | <input type="checkbox"/> | <input type="checkbox"/> | <input type="checkbox"/> | <input type="checkbox"/> | <input type="checkbox"/> | <input type="checkbox"/> | 51.0# | \$ 944 | | | | | | | | |
| | | Upholstered Seat | L2LT2/NA/PBR | <input type="checkbox"/> | <input type="checkbox"/> | <input type="checkbox"/> | <input type="checkbox"/> | <input type="checkbox"/> | <input type="checkbox"/> | <input type="checkbox"/> | <input type="checkbox"/> | 53.0# | N/A | 1011 | 1044 | 1061 | 1052 | 1104 | 1127 | 1154 |
|  2LWS1 2LWS2 | Flat Accessory Rack • One-piece shell • Passive back flex • Non-handed worksurface in choice of plastic or laminate • Flat accessory rack included | Polypropylene | L2LT1/NA/FBR | <input type="checkbox"/> | <input type="checkbox"/> | <input type="checkbox"/> | <input type="checkbox"/> | <input type="checkbox"/> | <input type="checkbox"/> | <input type="checkbox"/> | 57.0# | \$ 953 | | | | | | | | |
| | | Upholstered Seat | L2LT2/NA/FBR | <input type="checkbox"/> | <input type="checkbox"/> | <input type="checkbox"/> | <input type="checkbox"/> | <input type="checkbox"/> | <input type="checkbox"/> | <input type="checkbox"/> | <input type="checkbox"/> | 59.0# | N/A | 1028 | 1061 | 1078 | 1069 | 1121 | 1144 | 1171 |

A **B** **C** **D** **E** **F** **G** **H**

HOW TO ORDER

- Indicate the following information on order form:
- Quantity of each item.
 - Model number, including options. See "How To Build a Model Number".
 - Any special service required.

Note: • The indicates that a choice is required.
 • The absence of the indicates that no choice is required.
 • Alpha-numeric characters in place of indicate that no other alternatives are available.

HOW TO BUILD A MODEL NUMBER

- A** Select basic model.
- B** Select worksurface type.
 LW - Laminated worksurface
 PW - Plastic worksurface
- C** Select frame color.
 Refer to the **Product Color Options** page in this price list.
- D** Select fire code.
 NFR - Compliance to TB 117-2013
 FR - Compliance to TB 133
 See Upholstery Information for TB133 upcharge.
- E** Select poly seat and back color.
 Refer to the **Product Color Options** page in this price list.
- F** Select surface finish.
 Refer to the **Product Color Options** page in this price list.

- G** Select caster/glide option.
 C - Carpet casters
 S - Hard floor casters
 GL - Glides
 SCG - Front hard floor casters, rear glides
 CCG - Front carpet casters, rear glides
- H** Select upholstery grade/color.
 Refer to ki.com/fabrics

UPHOLSTERY INFORMATION

C.O.M. Upholstery
 C.O.M. requirement for 10 chairs or less with upholstered seat or upholstered seat and back is 3/4 yard per chair of 54" wide nondirectional fabric. For orders of 11 or more with upholstered seat and back and for complete information on ordering C.O.M. see "Ordering C.O.M., C.O.V. and C.O.L." section.

California TB133 Fire Safety Code
 For California Technical Bulletin 133 compliant models, add the following upcharge:
 Model=Polypropylene
 Added List Price=\$13
 Model=Upholstered Seat
 Added List Price=\$85

FINISH INFORMATION

Poly Bookbag Rack comes standard in Black. Other KI standard poly colors are available through a Product Modification Request. No upcharge or fees apply for orders of 20 or more. A net setup fee applies for orders of 19 or less. Please allow up 1 week additional leadtime.

SPECIAL SERVICES



Special Carton Marking

With specially marked information N/C

Shipping
 Ships assembled, FOB Green Bay, WI 54302, freight prepaid. Freight class 300.

Specifications and prices are subject to change without prior notice.



| MODEL | Features | MODEL NUMBER | | | | | | | | Approx. Packaged Weight | Delivered Pricing | Delivered Pricing Fabric Grade 1, C.O.M. & COV | Delivered Pricing Fabric Grade 2 | Delivered Pricing Fabric Grade 3 & Group 2V Vinyl | Delivered Pricing Pallas Fabric Group P0 | Delivered Pricing Pallas Fabric Group P1 | Delivered Pricing Pallas Fabric Group P2 | Delivered Pricing Pallas Fabric Group P3 | Delivered Pricing Pallas Fabric Group P4 |
|--------------------------------------------------------------------------------------------------------------------------------------------------------------------------------------------------------------------------------------------|------------------|---------------|--------------------------|--------------------------|--------------------------|--------------------------|------------------------------|--------------------------|--------------------------|-------------------------|-------------------|------------------------------------------------|----------------------------------|---------------------------------------------------|------------------------------------------|------------------------------------------|------------------------------------------|------------------------------------------|------------------------------------------|
| | | Basic Model | Surface Type | Frame Color | Fire Code | Shell Color | Surface Finish/Plastic Color | Glide Option | Uph. Color | | | | | | | | | | |
|  Without Accessory Rack • Non-handed worksurface in choice of plastic or laminate | Polypropylene | L2STP/NA/NAR | <input type="checkbox"/> | <input type="checkbox"/> | <input type="checkbox"/> | <input type="checkbox"/> | <input type="checkbox"/> | <input type="checkbox"/> | <input type="checkbox"/> | 48.0# | \$ 870 | | | | | | | | |
| | Upholstered Seat | L2STUS/NA/NAR | <input type="checkbox"/> | <input type="checkbox"/> | <input type="checkbox"/> | <input type="checkbox"/> | <input type="checkbox"/> | <input type="checkbox"/> | <input type="checkbox"/> | 51.0# | N/A | 946 | 981 | 997 | 989 | 1041 | 1064 | 1091 | 1113 |
| 2SWSP 2SWSU | | | | | | | | | | | | | | | | | | | |
|  Accessory Rack • Non-handed worksurface in choice of plastic or laminate • Accessory rack included on both sides of frame | Polypropylene | L2STP/NA/SAR | <input type="checkbox"/> | <input type="checkbox"/> | <input type="checkbox"/> | <input type="checkbox"/> | <input type="checkbox"/> | <input type="checkbox"/> | <input type="checkbox"/> | 57.0# | \$ 899 | | | | | | | | |
| | Upholstered Seat | L2STUS/NA/SAR | <input type="checkbox"/> | <input type="checkbox"/> | <input type="checkbox"/> | <input type="checkbox"/> | <input type="checkbox"/> | <input type="checkbox"/> | <input type="checkbox"/> | 60.0# | N/A | 976 | 1011 | 1025 | 1019 | 1068 | 1093 | 1120 | 1142 |
| 2SWSP 2SWSU | | | | | | | | | | | | | | | | | | | |
|  Cup Holder/Accessory Rack • Non-handed worksurface in choice of plastic or laminate • Cup holder/accessory rack included on both sides of frame | Polypropylene | L2STP/NA/CAR | <input type="checkbox"/> | <input type="checkbox"/> | <input type="checkbox"/> | <input type="checkbox"/> | <input type="checkbox"/> | <input type="checkbox"/> | <input type="checkbox"/> | 57.0# | \$ 947 | | | | | | | | |
| | Upholstered Seat | L2STUS/NA/CAR | <input type="checkbox"/> | <input type="checkbox"/> | <input type="checkbox"/> | <input type="checkbox"/> | <input type="checkbox"/> | <input type="checkbox"/> | <input type="checkbox"/> | 60.0# | N/A | 1022 | 1059 | 1072 | 1066 | 1118 | 1142 | 1168 | 1189 |
| 2SWSP 2SWSU | | | | | | | | | | | | | | | | | | | |

A **B** **C** **D** **E** **F** **G** **H**

HOW TO ORDER

- Indicate the following information on order form:
- Quantity of each item.
 - Model number, including options. See "How To Build a Model Number".
 - Any special service required.

Note: • The indicates that a choice is required.
 • The absence of the indicates that no choice is required.
 • Alpha-numeric characters in place of indicate that no other alternatives are available.

HOW TO BUILD A MODEL NUMBER

- A** Select basic model.
- B** Select worksurface type.
 LW - Laminate worksurface; add \$65
 PW - Plastic worksurface
- C** Select frame color.
 Refer to the **Product Color Options** page in this price list.
- D** Select fire code.
 FR - Compliance to TB 133
 NFR - Compliance to TB 117-2013
 See Upholstery Information for TB133 upcharge.
- E** Select poly seat and back color.
 Refer to the **Product Color Options** page in this price list.
- F** Select surface finish.
 Refer to the **Product Color Options** page in this price list.
- G** Select caster/glide option.
 C - Carpet casters
 S - Hard floor casters
 GL - Glides
 SCG - Front hard floor casters, rear glides
 CCG - Front carpet casters, rear glides
- H** Select upholstery grade/color.
 Refer to ki.com/fabrics

UPHOLSTERY INFORMATION

C.O.M. Upholstery
 C.O.M. requirement for 10 chairs or less with upholstered seat or upholstered seat and back is 3/4 yard per chair of 54" wide nondirectional fabric. For orders of 11 or more with upholstered seat and back and for complete information on ordering C.O.M. see "Ordering C.O.M., C.O.V. and C.O.L." section.

California TB133 Fire Safety Code
 For California Technical Bulletin 133 compliant models, add the following upcharge:
 Model=Polypropylene
 Added List Price=\$13
 Model=Upholstered Seat
 Added List Price=\$85



SPECIAL SERVICES

Special Carton Marking
 With specially marked information N/C

Shipping
 Ships assembled, FOB Green Bay, WI 54302, freight prepaid. Freight class 300.

Specifications and prices are subject to change without prior notice.



| MODEL | Features | MODEL NUMBER | | | | | | | | Approx. Packaged Weight | Delivered Pricing | Delivered Pricing Fabric Grade 1, C.O.M. & COV | Delivered Pricing Fabric Grade 2 | Delivered Pricing Fabric Grade 3 & Group 2V Vinyl | Delivered Pricing Pallas Fabric Group P0 | Delivered Pricing Pallas Fabric Group P1 | Delivered Pricing Pallas Fabric Group P2 | Delivered Pricing Pallas Fabric Group P3 | Delivered Pricing Pallas Fabric Group P4 |
|----------------------------------------------------------------------------------------------------|---------------------------------------------------------------------------------------------------------------------------------------------------------------------------------------------------------------------------------------------|------------------|---------------|--------------------------|--------------------------|--------------------------|------------------------------|--------------------------|--------------------------|--------------------------|-------------------|------------------------------------------------|----------------------------------|---------------------------------------------------|------------------------------------------|------------------------------------------|------------------------------------------|------------------------------------------|------------------------------------------|
| | | Basic Model | Surface Type | Frame Color | Fire Code | Shell Color | Surface Finish/Plastic Color | Glide Option | Uph. Color | | | | | | | | | | |
|  2SWSP 2SWSU | Poly Bookbag Rack • Non-handed worksurface in choice of plastic or laminate • Poly bookbag rack included • Poly bookbag rack includes two accessory slots and a cupholder • Poly Bookbag rack is only available in black | Polypropylene | L2STP/NA/PBR | <input type="checkbox"/> | <input type="checkbox"/> | <input type="checkbox"/> | <input type="checkbox"/> | <input type="checkbox"/> | <input type="checkbox"/> | 57.0# | \$ 938 | | | | | | | | |
| | | Upholstered Seat | L2STUS/NA/PBR | <input type="checkbox"/> | <input type="checkbox"/> | <input type="checkbox"/> | <input type="checkbox"/> | <input type="checkbox"/> | <input type="checkbox"/> | <input type="checkbox"/> | 60.0# | N/A | 1005 | 1038 | 1055 | 1046 | 1099 | 1121 | 1148 |
|  2SWSP 2SWSU | Flat Accessory Rack • Non-handed worksurface in choice of plastic or laminate • Flat accessory rack included | Polypropylene | L2STP/NA/FBR | <input type="checkbox"/> | <input type="checkbox"/> | <input type="checkbox"/> | <input type="checkbox"/> | <input type="checkbox"/> | <input type="checkbox"/> | 57.0# | \$ 947 | | | | | | | | |
| | | Upholstered Seat | L2STUS/NA/FBR | <input type="checkbox"/> | <input type="checkbox"/> | <input type="checkbox"/> | <input type="checkbox"/> | <input type="checkbox"/> | <input type="checkbox"/> | <input type="checkbox"/> | 60.0# | N/A | 1022 | 1059 | 1072 | 1066 | 1118 | 1142 | 1168 |

A **B** **C** **D** **E** **F** **G** **H**

HOW TO ORDER

- Indicate the following information on order form:
- Quantity of each item.
 - Model number, including options. See "How To Build a Model Number".
 - Any special service required.

Note:

- The indicates that a choice is required.
- The absence of the indicates that no choice is required.
- Alpha-numeric characters in place of indicate that no other alternatives are available.

HOW TO BUILD A MODEL NUMBER

- A** Select basic model.
- B** Select worksurface type.
 - LW** - Laminate worksurface; add \$65
 - PW** - Plastic worksurface
- C** Select frame color. Refer to the **Product Color Options** page in this price list.
- D** Select fire code.
 - FR** - Compliance to TB 133
 - NFR** - Compliance to TB 117-2013
 See Upholstery Information for TB133 upcharge.
- E** Select poly seat and back color. Refer to the **Product Color Options** page in this price list.
- F** Select surface finish. Refer to the **Product Color Options** page in this price list.
- G** Select caster/glide option.
 - C** - Carpet casters
 - S** - Hard floor casters
 - GL** - Glides
 - SCG** - Front hard floor casters, rear glides
 - CCG** - Front carpet casters, rear glides
- H** Select upholstery grade/color. Refer to ki.com/fabrics

UPHOLSTERY INFORMATION

C.O.M. Upholstery
 C.O.M. requirement for 10 chairs or less with upholstered seat or upholstered seat and back is 3/4 yard per chair of 54" wide nondirectional fabric. For orders of 11 or more with upholstered seat and back and for complete information on ordering C.O.M. see "Ordering C.O.M., C.O.V. and C.O.L." section.

California TB133 Fire Safety Code
 For California Technical Bulletin 133 compliant models, add the following upcharge:
 Model=Polypropylene
 Added List Price=\$13
 Model=Upholstered Seat
 Added List Price=\$85

FINISH INFORMATION

Poly Bookbag Rack comes standard in Black. Other KI standard poly colors are available through a Product Modification Request. No upcharge or fees apply for orders of 20 or more. A net setup fee applies for orders of 19 or less. Please allow up 1 week additional leadtime.

SPECIAL SERVICES



Special Carton Marking

With specially marked information N/C

Shipping
 Ships **assembled, FOB Green Bay, WI 54302, freight prepaid.** Freight class 300.

Specifications and prices are subject to change without prior notice.



| MODEL | Features | MODEL NUMBER | | | | | | | | | Approx. Packaged Weight | Delivered Pricing | Delivered Pricing Fabric Grade 1, C.O.M. & COV | Delivered Pricing Fabric Grade 2 | Delivered Pricing Fabric Grade 3 & Group 2V Vinyl | Delivered Pricing Pallas Fabric Group P0 | Delivered Pricing Pallas Fabric Group P1 | Delivered Pricing Pallas Fabric Group P2 | Delivered Pricing Pallas Fabric Group P3 | Delivered Pricing Pallas Fabric Group P4 | |
|-----------------------------------------------------------------------------------------------------|----------------------------------------------------------------------------------------------------------------------------------------------------------------------------|------------------|---------------|--------------------------|--------------------------|--------------------------|------------------------------|--------------------------|--------------------------|--------------------------|--------------------------|-------------------|------------------------------------------------|----------------------------------|---------------------------------------------------|------------------------------------------|------------------------------------------|------------------------------------------|------------------------------------------|------------------------------------------|------|
| | | Basic Model | Surface Type | Frame Color | Fire Code | Shell Color | Surface Finish/Plastic Color | Glide Option | Uph. Color | | | | | | | | | | | | |
|  2SWSP 2SWSU | Armchair without Accessory Rack • Non-handed worksurface in choice of plastic or laminate | Polypropylene | L2STP/CA/NAR | <input type="checkbox"/> | <input type="checkbox"/> | <input type="checkbox"/> | <input type="checkbox"/> | <input type="checkbox"/> | <input type="checkbox"/> | <input type="checkbox"/> | 51.0# | \$ 944 | | | | | | | | | |
| | | Upholstered Seat | L2STUS/CA/NAR | <input type="checkbox"/> | <input type="checkbox"/> | <input type="checkbox"/> | <input type="checkbox"/> | <input type="checkbox"/> | <input type="checkbox"/> | <input type="checkbox"/> | <input type="checkbox"/> | 54.0# | N/A | 1019 | 1052 | 1068 | 1062 | 1113 | 1138 | 1164 | 1185 |
|  2SWSP 2SWSU | Armchair with Accessory Rack • Non-handed worksurface in choice of plastic or laminate • Accessory rack included on both sides of frame | Polypropylene | L2STP/CA/SAR | <input type="checkbox"/> | <input type="checkbox"/> | <input type="checkbox"/> | <input type="checkbox"/> | <input type="checkbox"/> | <input type="checkbox"/> | <input type="checkbox"/> | 60.0# | \$ 971 | | | | | | | | | |
| | | Upholstered Seat | L2STUS/CA/SAR | <input type="checkbox"/> | <input type="checkbox"/> | <input type="checkbox"/> | <input type="checkbox"/> | <input type="checkbox"/> | <input type="checkbox"/> | <input type="checkbox"/> | <input type="checkbox"/> | 63.0# | N/A | 1048 | 1083 | 1098 | 1091 | 1142 | 1167 | 1193 | 1214 |
|  2SWSP 2SWSU | Armchair with Cup Holder/Accessory Rack • Non-handed worksurface in choice of plastic or laminate • Cup holder/accessory rack included on both sides of frame | Polypropylene | L2STP/CA/CAR | <input type="checkbox"/> | <input type="checkbox"/> | <input type="checkbox"/> | <input type="checkbox"/> | <input type="checkbox"/> | <input type="checkbox"/> | <input type="checkbox"/> | 60.0# | \$ 1020 | | | | | | | | | |
| | | Upholstered Seat | L2STUS/CA/CAR | <input type="checkbox"/> | <input type="checkbox"/> | <input type="checkbox"/> | <input type="checkbox"/> | <input type="checkbox"/> | <input type="checkbox"/> | <input type="checkbox"/> | <input type="checkbox"/> | 63.0# | N/A | 1094 | 1129 | 1146 | 1139 | 1189 | 1214 | 1241 | 1262 |

A **B** **C** **D** **E** **F** **G** **H**

HOW TO ORDER

- Indicate the following information on order form:
- Quantity of each item.
 - Model number, including options. See "How To Build a Model Number".
 - Any special service required.

Note: • The indicates that a choice is required.
 • The absence of the indicates that no choice is required.
 • Alpha-numeric characters in place of indicate that no other alternatives are available.

HOW TO BUILD A MODEL NUMBER

- A** Select basic model.
- B** Select worksurface type.
 LW - Laminate worksurface; add \$65
 PW - Plastic worksurface
- C** Select frame color.
 Refer to the **Product Color Options** page in this price list.
- D** Select fire code.
 FR - Compliance to TB 133
 NFR - Compliance to TB 117-2013
 See Upholstery Information for TB133 upcharge.
- E** Select poly seat and back color.
 Refer to the **Product Color Options** page in this price list.
- F** Select surface finish.
 Refer to the **Product Color Options** page in this price list.
- G** Select caster/glide option.
 C - Carpet casters
 S - Hard floor casters
 GL - Glides
 SCG - Front hard floor casters, rear glides
 CCG - Front carpet casters, rear glides
- H** Select upholstery grade/color.
 Refer to ki.com/fabrics

UPHOLSTERY INFORMATION

C.O.M. Upholstery
 C.O.M. requirement for 10 chairs or less with upholstered seat or upholstered seat and back is 3/4 yard per chair of 54" wide nondirectional fabric. For orders of 11 or more with upholstered seat and back and for complete information on ordering C.O.M. see "Ordering C.O.M., C.O.V. and C.O.L." section.

California TB133 Fire Safety Code
 For California Technical Bulletin 133 compliant models, add the following upcharge:
 Model=Polypropylene
 Added List Price=\$13
 Model=Upholstered Seat
 Added List Price=\$85



SPECIAL SERVICES

Special Carton Marking
 With specially marked information N/C

Shipping
 Ships assembled, FOB Green Bay, WI 54302, freight prepaid. Freight class 300.

Specifications and prices are subject to change without prior notice.



| MODEL | Features | MODEL NUMBER | | | | | | | | Approx. Packaged Weight | Delivered Pricing | Delivered Pricing Fabric Grade 1, C.O.M. & COV | Delivered Pricing Fabric Grade 2 | Delivered Pricing Fabric Grade 3 & Group 2V Vinyl | Delivered Pricing Pallas Fabric Group P0 | Delivered Pricing Pallas Fabric Group P1 | Delivered Pricing Pallas Fabric Group P2 | Delivered Pricing Pallas Fabric Group P3 | Delivered Pricing Pallas Fabric Group P4 | |
|--------------------------------------------------------------------------------------------------------------------------------------------------------------------------------------------------------------------------------------------------------------------------------------------------------------------------------------------------------------------------------------------------------------------|------------------|---------------|--------------------------|--------------------------|--------------------------|--------------------------|------------------------------|--------------------------|--------------------------|--------------------------|-------------------|------------------------------------------------|----------------------------------|---------------------------------------------------|------------------------------------------|------------------------------------------|------------------------------------------|------------------------------------------|------------------------------------------|------|
| | | Basic Model | Surface Type | Frame Color | Fire Code | Shell Color | Surface Finish/Plastic Color | Glide Option | Uph. Color | | | | | | | | | | | |
|  <p>Armchair with Poly Bookbag Rack</p> <ul style="list-style-type: none"> • Non-handed worksurface in choice of plastic or laminate • Poly bookbag rack included • Poly bookbag rack includes two accessory slots and a cupholder • Poly Bookbag rack is only available in black | Polypropylene | L2STP/CA/PBR | <input type="checkbox"/> | <input type="checkbox"/> | <input type="checkbox"/> | <input type="checkbox"/> | <input type="checkbox"/> | <input type="checkbox"/> | <input type="checkbox"/> | 60.0# | \$ 1000 | | | | | | | | | |
| | Upholstered Seat | L2STUS/CA/PBR | <input type="checkbox"/> | <input type="checkbox"/> | <input type="checkbox"/> | <input type="checkbox"/> | <input type="checkbox"/> | <input type="checkbox"/> | <input type="checkbox"/> | <input type="checkbox"/> | 63.0# | N/A | 1076 | 1111 | 1126 | 1119 | 1170 | 1194 | 1221 | 1242 |
| 2SWSP | | | | | | | | | | | | | | | | | | | | |
| 2SWSU | | | | | | | | | | | | | | | | | | | | |
|  <p>Armchair with Flat Accessory Rack</p> <ul style="list-style-type: none"> • Non-handed worksurface in choice of plastic or laminate • Flat accessory rack included | Polypropylene | L2STP/CA/FBR | <input type="checkbox"/> | <input type="checkbox"/> | <input type="checkbox"/> | <input type="checkbox"/> | <input type="checkbox"/> | <input type="checkbox"/> | <input type="checkbox"/> | 60.0# | \$ 1020 | | | | | | | | | |
| | Upholstered Seat | L2STUS/CA/FBR | <input type="checkbox"/> | <input type="checkbox"/> | <input type="checkbox"/> | <input type="checkbox"/> | <input type="checkbox"/> | <input type="checkbox"/> | <input type="checkbox"/> | <input type="checkbox"/> | 63.0# | N/A | 1094 | 1129 | 1146 | 1139 | 1189 | 1214 | 1241 | 1262 |
| 2SWSP | | | | | | | | | | | | | | | | | | | | |
| 2SWSU | | | | | | | | | | | | | | | | | | | | |

A B C D E F G H

HOW TO ORDER

- Indicate the following information on order form:
1. Quantity of each item.
 2. Model number, including options. See "How To Build a Model Number".
 3. Any special service required.

Note:

- The indicates that a choice is required.
- The absence of the indicates that no choice is required.
- Alpha-numeric characters in place of indicate that no other alternatives are available.

HOW TO BUILD A MODEL NUMBER

- A** Select basic model.
 - LW** - Laminate worksurface; add \$65
 - PW** - Plastic worksurface
- B** Select worksurface type.
- C** Select frame color.
- D** Select fire code.
 - FR** - Compliance to TB 133
 - NFR** - Compliance to TB 117-2013
 See Upholstery Information for TB133 upcharge.
- E** Select poly seat and back color. Refer to the **Product Color Options** page in this price list.
- F** Select surface finish. Refer to the **Product Color Options** page in this price list.
- G** Select caster/glide option.
 - C** - Carpet casters
 - S** - Hard floor casters
 - GL** - Glides
 - SCG** - Front hard floor casters, rear glides
 - CCG** - Front carpet casters, rear glides
- H** Select upholstery grade/color. Refer to ki.com/fabrics

UPHOLSTERY INFORMATION

C.O.M. Upholstery
 C.O.M. requirement for 10 chairs or less with upholstered seat or upholstered seat and back is 3/4 yard per chair of 54" wide nondirectional fabric. For orders of 11 or more with upholstered seat and back and for complete information on ordering C.O.M. see "Ordering C.O.M., C.O.V. and C.O.L." section.

California TB133 Fire Safety Code
 For California Technical Bulletin 133 compliant models, add the following upcharge:
 Model=Polypropylene
 Added List Price=\$13
 Model=Upholstered Seat
 Added List Price=\$85

FINISH INFORMATION

Poly Bookbag Rack comes standard in Black. Other KI standard poly colors are available through a Product Modification Request. No upcharge or fees apply for orders of 20 or more. A net setup fee applies for orders of 19 or less. Please allow up 1 week additional leadtime.

SPECIAL SERVICES

Special Carton Marking

With specially marked information N/C

Shipping
 Ships assembled, FOB Green Bay, WI 54302, freight prepaid. Freight class 300.

Specifications and prices are subject to change without prior notice.

Learn2® Classroom Furniture (Delivered)

Doni® Seating without Worksurface



Learn2® Classroom Furniture (Delivered)

Doni® Seating without Worksurface

| Features | MODEL NUMBER | | | | | | | Approx. Packaged Weight | Delivered Pricing Unupholstered | Delivered Pricing Fabric Grade 1, C.O.M. & COV | Delivered Pricing Fabric Grade 2 | Delivered Pricing Fabric Grade 3 & Group 2V Vinyl | Delivered Pricing Pallas Fabric Group P0 | Delivered Pricing Pallas Fabric Group P1 | Delivered Pricing Pallas Fabric Group P2 | Delivered Pricing Pallas Fabric Group P3 | Delivered Pricing Pallas Fabric Group P4 |
|----------------------------------------------------------------------------------------------------------------------------------------------------------------------------------------------------------------------------|--------------|--------------------------|--------------------------|--------------------------|---------------------------|--------------------------|--------------------------|-------------------------|---------------------------------|------------------------------------------------|----------------------------------|---------------------------------------------------|------------------------------------------|------------------------------------------|------------------------------------------|------------------------------------------|------------------------------------------|
| | Basic Model | Frame Color | Fire Code | Poly Solid Color | Poly Outside/Inside Color | Glide Option | Uph. Color | | | | | | | | | | |
| Solid Color, Polypropylene | L2DN1/NAR | <input type="checkbox"/> | <input type="checkbox"/> | <input type="checkbox"/> | | <input type="checkbox"/> | | 57.0# | \$ 718 | | | | | | | | |
| Solid Color, Upholstered Seat | L2DN2/NAR | <input type="checkbox"/> | <input type="checkbox"/> | <input type="checkbox"/> | | <input type="checkbox"/> | <input type="checkbox"/> | 57.0# | N/A | 869 | 882 | 900 | 912 | 965 | 983 | 1009 | 1046 |
| Two-Tone, Polypropylene | L2DNA/NAR | <input type="checkbox"/> | NFR | | <input type="checkbox"/> | <input type="checkbox"/> | | 57.0# | 790 | | | | | | | | |
| Two-Tone, Upholstered Seat | L2DNB/NAR | <input type="checkbox"/> | NFR | | <input type="checkbox"/> | <input type="checkbox"/> | <input type="checkbox"/> | 57.0# | N/A | 939 | 950 | 971 | 983 | 1033 | 1052 | 1080 | 1117 |
| No Worksurface - Without Accessory Rack | | | | | | | | | | | | | | | | | |
| <ul style="list-style-type: none"> • Solid or two-tone colored shell • Unlimited color match's • 17 degrees of hip articulation | | | | | | | | | | | | | | | | | |
| Solid Color, Polypropylene | L2DN1/SAR | <input type="checkbox"/> | <input type="checkbox"/> | <input type="checkbox"/> | | <input type="checkbox"/> | | 57.0# | \$ 750 | | | | | | | | |
| Solid Color, Upholstered Seat | L2DN2/SAR | <input type="checkbox"/> | <input type="checkbox"/> | <input type="checkbox"/> | | <input type="checkbox"/> | <input type="checkbox"/> | 57.0# | N/A | 898 | 910 | 931 | 942 | 992 | 1013 | 1038 | 1076 |
| Two-Tone, Polypropylene | L2DNA/SAR | <input type="checkbox"/> | NFR | | <input type="checkbox"/> | <input type="checkbox"/> | | 57.0# | 819 | | | | | | | | |
| Two-Tone, Upholstered Seat | L2DNB/SAR | <input type="checkbox"/> | NFR | | <input type="checkbox"/> | <input type="checkbox"/> | <input type="checkbox"/> | 57.0# | N/A | 969 | 981 | 1000 | 1013 | 1063 | 1084 | 1110 | 1144 |
| No Worksurface - Accessory Rack | | | | | | | | | | | | | | | | | |
| <ul style="list-style-type: none"> • Accessory rack included on both sides of frame • Solid or two-tone colored shell • Unlimited color match's • 17 degrees of hip articulation | | | | | | | | | | | | | | | | | |

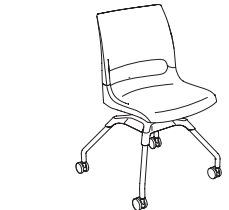

2DNS1
2DNS2
2DNSA
2DNSB

No Worksurface - Without Accessory Rack

- Solid or two-tone colored shell
- Unlimited color match's
- 17 degrees of hip articulation



2DNS1
2DNS2
2DNSA
2DNSB

No Worksurface - Accessory Rack

- Accessory rack included on both sides of frame
- Solid or two-tone colored shell
- Unlimited color match's
- 17 degrees of hip articulation

HOW TO ORDER

- Indicate the following information on order form:
- Quantity of each item.
 - Model number, including options. See "How To Build a Model Number".
 - Any special service required.

Note: • The indicates that a choice is required.
• The absence of the indicates that no choice is required.
• Alpha-numeric characters in place of indicate that no other alternatives are available.

HOW TO BUILD A MODEL NUMBER

- A** Select basic model.
- B** Select frame color. Refer to the **Product Color Options** page in this price list.
- C** Select fire code.

| | |
|------------|-----------------------------|
| NFR | - Compliance to TB 117-2013 |
| FR | - Compliance to TB 133 |
- D** Select solid poly color. Refer to the **Product Color Options** page in this price list.
- E** Select outside/inside poly color. Refer to the **Product Color Options** page in this price list.
- F** Select caster/glide option.

| | |
|------------|-----------------------------------------|
| C | - Carpet casters |
| S | - Hard floor casters |
| GL | - Glides |
| SCG | - Front hard floor casters, rear glides |
- G** Select upholstery grade/color. Refer to ki.com/fabrics

UPHOLSTERY INFORMATION

C.O.M. Upholstery
C.O.M. requirement for 10 chairs or less with upholstered seat or upholstered seat and back is 3/4 yard per chair of 54" wide nondirectional fabric. For orders of 11 or more with upholstered seat and back and for complete information on ordering C.O.M. see "Ordering C.O.M., C.O.V. and C.O.L." section.

California TB133 Fire Safety Code
For California Technical Bulletin 133 compliant models, add the following upcharge:
Model=Solid Color, Polypropylene
Added List Price=\$13
Model=Solid Color, Upholstered Seat
Added List Price=\$90

SPECIAL SERVICES

Special Carton Marking
With specially marked information N/C

Shipping
Ships assembled, FOB Green Bay, WI 54302, freight prepaid. Freight class 300.

Specifications and prices are subject to change without prior notice.

Learn2® Classroom Furniture (Delivered)

Doni® Seating without Worksurface



Learn2® Classroom Furniture (Delivered)

Doni® Seating without Worksurface

| Features | MODEL NUMBER | | | | | | | Approx. Packaged Weight | Delivered Pricing Unupholstered | Delivered Pricing Fabric Grade 1, C.O.M. & COV | Delivered Pricing Fabric Grade 2 | Delivered Pricing Fabric Grade 3 & Group 2V Vinyl | Delivered Pricing Pallas Fabric Group P0 | Delivered Pricing Pallas Fabric Group P1 | Delivered Pricing Pallas Fabric Group P2 | Delivered Pricing Pallas Fabric Group P3 | Delivered Pricing Pallas Fabric Group P4 |
|-------------------------------|--------------|--------------------------|--------------------------|--------------------------|---------------------------|--------------------------|--------------------------|-------------------------|---------------------------------|------------------------------------------------|----------------------------------|---------------------------------------------------|------------------------------------------|------------------------------------------|------------------------------------------|------------------------------------------|------------------------------------------|
| | Basic Model | Frame Color | Fire Code | Poly Solid Color | Poly Outside/Inside Color | Glide Option | Uph. Color | | | | | | | | | | |
| Solid Color, Polypropylene | L2DN1/CAR | <input type="checkbox"/> | <input type="checkbox"/> | <input type="checkbox"/> | | <input type="checkbox"/> | | 57.0# | \$ 796 | | | | | | | | |
| Solid Color, Upholstered Seat | L2DN2/CAR | <input type="checkbox"/> | <input type="checkbox"/> | <input type="checkbox"/> | | <input type="checkbox"/> | <input type="checkbox"/> | 57.0# | N/A | 946 | 958 | 980 | 990 | 1041 | 1061 | 1087 | 1123 |
| Two-Tone, Polypropylene | L2DNA/CAR | <input type="checkbox"/> | NFR | | <input type="checkbox"/> | <input type="checkbox"/> | | 57.0# | 866 | | | | | | | | |
| Two-Tone, Upholstered Seat | L2DNB/CAR | <input type="checkbox"/> | NFR | | <input type="checkbox"/> | <input type="checkbox"/> | <input type="checkbox"/> | 57.0# | N/A | 1018 | 1027 | 1049 | 1061 | 1112 | 1131 | 1158 | 1193 |



- 2DNS1
- 2DNS2
- 2DNSA
- 2DNSB

- No Worksurface - Cup Holder/Accessory Rack**
- Cup holder/accessory rack included on both sides of frame
 - Solid or two-tone colored shell
 - Unlimited color match's
 - 17 degrees of hip articulation

A **B** **C** **D** **E** **F** **G**

HOW TO ORDER

- Indicate the following information on order form:
- Quantity of each item.
 - Model number, including options. See "How To Build a Model Number".
 - Any special service required.

- Note:
- The indicates that a choice is required.
 - The absence of the indicates that no choice is required.
 - Alpha-numeric characters in place of indicate that no other alternatives are available.

HOW TO BUILD A MODEL NUMBER

- A** Select basic model.
- B** Select frame color. Refer to the **Product Color Options** page in this price list.
- C** Select fire code.

| | |
|------------|-----------------------------|
| NFR | - Compliance to TB 117-2013 |
| FR | - Compliance to TB 133 |
- D** Select solid poly color. Refer to the **Product Color Options** page in this price list.
- E** Select outside/inside poly color. Refer to the **Product Color Options** page in this price list.
- F** Select caster/glide option.

| | |
|------------|----------------------------------|
| C | - Carpet casters |
| S | - Hard floor casters |
| GL | - Glides |
| SCG | - Front hard floor casters, rear |

- | | |
|---------------|-------------------------------------|
| glides | |
| CCG | - Front carpet casters, rear glides |
- G** Select upholstery grade/color. Refer to ki.com/fabrics

UPHOLSTERY INFORMATION

C.O.M. Upholstery
 C.O.M. requirement for 10 chairs or less with upholstered seat or upholstered seat and back is 3/4 yard per chair of 54" wide nondirectional fabric. For orders of 11 or more with upholstered seat and back and for complete information on ordering C.O.M. see "Ordering C.O.M., C.O.V. and C.O.L." section.

California TB133 Fire Safety Code
 For California Technical Bulletin 133 compliant models, add the following upcharge:
 Model=Solid Color, Polypropylene
 Added List Price=\$13
 Model=Solid Color, Upholstered Seat
 Added List Price=\$90

SPECIAL SERVICES

Special Carton Marking

With specially marked information N/C

Shipping
 Ships **assembled, FOB Green Bay, WI 54302, freight prepaid.** Freight class 300.

Specifications and prices are subject to change without prior notice.

Learn2® Classroom Furniture (Delivered)

Doni® Seating without Worksurface



Learn2® Classroom Furniture (Delivered)

Doni® Seating without Worksurface

| MODEL | Features | MODEL NUMBER | | | | | | | Approx. Packaged Weight | Delivered Pricing Unupholstered | Delivered Pricing Fabric Grade 1, C.O.M. & COV | Delivered Pricing Fabric Grade 2 | Delivered Pricing Fabric Grade 3 & Group 2V Vinyl | Delivered Pricing Pallas Fabric Group P0 | Delivered Pricing Pallas Fabric Group P1 | Delivered Pricing Pallas Fabric Group P2 | Delivered Pricing Pallas Fabric Group P3 | Delivered Pricing Pallas Fabric Group P4 | |
|---------------------------------------------------------------------------------------------------------------------------------------------------------------------------------------------------------------------------------------------------------------------------------------------------------------------------------------|-------------------------------|--------------|--------------------------|--------------------------|--------------------------|---------------------------|--------------------------|--------------------------|-------------------------|---------------------------------|------------------------------------------------|----------------------------------|---------------------------------------------------|------------------------------------------|------------------------------------------|------------------------------------------|------------------------------------------|------------------------------------------|--|
| | | Basic Model | Frame Color | Fire Code | Poly Solid Color | Poly Outside/Inside Color | Glide Option | Uph. Color | | | | | | | | | | | |
|  <p>No Worksurface - Flat Accessory Rack</p> <ul style="list-style-type: none"> Flat accessory rack included Solid or two-tone colored shell Unlimited color match's 17 degrees of hip articulation | Solid Color, Polypropylene | L2DN1/FBR | <input type="checkbox"/> | <input type="checkbox"/> | <input type="checkbox"/> | | <input type="checkbox"/> | | 57.0# | \$ 796 | | | | | | | | | |
| | Solid Color, Upholstered Seat | L2DN2/FBR | <input type="checkbox"/> | <input type="checkbox"/> | <input type="checkbox"/> | | <input type="checkbox"/> | <input type="checkbox"/> | 57.0# | N/A | 946 | 958 | 980 | 990 | 1041 | 1061 | 1087 | 1123 | |
| | Two-Tone, Polypropylene | L2DNA/FBR | <input type="checkbox"/> | NFR | | <input type="checkbox"/> | <input type="checkbox"/> | <input type="checkbox"/> | 57.0# | 866 | | | | | | | | | |
| | Two-Tone, Upholstered Seat | L2DNB/FBR | <input type="checkbox"/> | NFR | | <input type="checkbox"/> | <input type="checkbox"/> | <input type="checkbox"/> | 57.0# | N/A | 1018 | 1027 | 1049 | 1061 | 1112 | 1131 | 1158 | 1193 | |
| | | | | | | | | | | | | | | | | | | | |
| | | | | | | | | | | | | | | | | | | | |
| | | | | | | | | | | | | | | | | | | | |
| | | | | | | | | | | | | | | | | | | | |
| | | | | | | | | | | | | | | | | | | | |
| | | | | | | | | | | | | | | | | | | | |

2DNS1
2DNS2
2DNSA
2DNSB

HOW TO ORDER

- Indicate the following information on order form:
- Quantity of each item.
 - Model number, including options. See "How To Build a Model Number".
 - Any special service required.

Note:

- The indicates that a choice is required.
- The absence of the indicates that no choice is required.
- Alpha-numeric characters in place of indicate that no other alternatives are available.

HOW TO BUILD A MODEL NUMBER

- A** Select basic model.
- B** Select frame color. Refer to the **Product Color Options** page in this price list.
- C** Select fire code.

| | |
|------------|-----------------------------|
| NFR | - Compliance to TB 117-2013 |
| FR | - Compliance to TB 133 |
- D** Select solid poly color. Refer to the **Product Color Options** page in this price list.
- E** Select outside/inside poly color. Refer to the **Product Color Options** page in this price list.
- F** Select caster/glide option.

| | |
|------------|----------------------------------|
| C | - Carpet casters |
| S | - Hard floor casters |
| GL | - Glides |
| SCG | - Front hard floor casters, rear |

glides
CCG - Front carpet casters, rear glides

G Select upholstery grade/color. Refer to ki.com/fabrics

UPHOLSTERY INFORMATION

C.O.M. Upholstery
C.O.M. requirement for 10 chairs or less with upholstered seat or upholstered seat and back is 3/4 yard per chair of 54" wide nondirectional fabric. For orders of 11 or more with upholstered seat and back and for complete information on ordering C.O.M. see "Ordering C.O.M., C.O.V. and C.O.L." section.

California TB133 Fire Safety Code
For California Technical Bulletin 133 compliant models, add the following upcharge:
Model=Solid Color, Polypropylene
Added List Price=\$13
Model=Solid Color, Upholstered Seat
Added List Price=\$90



SPECIAL SERVICES

Special Carton Marking
With specially marked information N/C

Shipping
Ships **assembled, FOB Green Bay, WI 54302, freight prepaid.** Freight class 300.

Specifications and prices are subject to change without prior notice.



| MODEL | Features | MODEL NUMBER | | | | | | Approx. Packaged Weight | Delivered Pricing | Delivered Pricing Fabric Grade 1, C.O.M. & COV | Delivered Pricing Fabric Grade 2 | Delivered Pricing Fabric Grade 3 & Group 2V Vinyl | Delivered Pricing Pallas Fabric Group P0 | Delivered Pricing Pallas Fabric Group P1 | Delivered Pricing Pallas Fabric Group P2 | Delivered Pricing Pallas Fabric Group P3 | Delivered Pricing Pallas Fabric Group P4 |
|------------------------------------------------------------------------------------------------------|------------------------------------------------------------------------------------------------------------------|------------------|-------------|--------------------------|--------------------------|--------------------------|--------------------------|-------------------------|-------------------|------------------------------------------------|----------------------------------|---------------------------------------------------|------------------------------------------|------------------------------------------|------------------------------------------|------------------------------------------|------------------------------------------|
| | | Basic Model | Frame Color | Fire Code | Shell Color | Glide Option | Upholstery Color | | | | | | | | | | |
|  2WNSP 2WNSU | No Worksurface - Without Accessory Rack | Polypropylene | L2WNP/NAR | <input type="checkbox"/> | <input type="checkbox"/> | <input type="checkbox"/> | <input type="checkbox"/> | 33.0# | \$ 547 | | | | | | | | |
| | | Upholstered Seat | L2WNUS/NAR | <input type="checkbox"/> | <input type="checkbox"/> | <input type="checkbox"/> | <input type="checkbox"/> | 36.0# | N/A | 618 | 624 | 635 | 624 | 674 | 692 | 714 | 731 |
|  2WNSP 2WNSU | No Worksurface - Accessory Rack • Accessory rack included on both sides of frame | Polypropylene | L2WNP/SAR | <input type="checkbox"/> | <input type="checkbox"/> | <input type="checkbox"/> | <input type="checkbox"/> | 42.0# | \$ 575 | | | | | | | | |
| | | Upholstered Seat | L2WNUS/SAR | <input type="checkbox"/> | <input type="checkbox"/> | <input type="checkbox"/> | <input type="checkbox"/> | 45.0# | N/A | 648 | 655 | 664 | 655 | 704 | 720 | 741 | 760 |
|  2WNSP 2WNSU | No Worksurface - Cup Holder/Accessory Rack • Cup holder/accessory rack included on both sides of frame | Polypropylene | L2WNP/CAR | <input type="checkbox"/> | <input type="checkbox"/> | <input type="checkbox"/> | <input type="checkbox"/> | 42.0# | \$ 623 | | | | | | | | |
| | | Upholstered Seat | L2WNUS/CAR | <input type="checkbox"/> | <input type="checkbox"/> | <input type="checkbox"/> | <input type="checkbox"/> | 45.0# | N/A | 695 | 700 | 713 | 700 | 753 | 768 | 790 | 808 |

A **B** **C** **D** **E** **F**

HOW TO ORDER

- Indicate the following information on order form:
- Quantity of each item.
 - Model number, including options. See "How To Build a Model Number".
 - Any special service required.

Note: • The indicates that a choice is required.
 • The absence of the indicates that no choice is required.
 • Alpha-numeric characters in place of indicate that no other alternatives are available.

HOW TO BUILD A MODEL NUMBER

- A** Select basic model.
- B** Select frame color. Refer to the **Product Color Options** page in this price list.
- C** Select fire code.
 - FR** - Compliance to TB 133
 - NFR** - Compliance to TB 117-2013
 See Upholstery Information for TB133 upcharge.
- D** Select shell color. Refer to the **Product Color Options** page in this price list.
- E** Select caster/glide option.
 - C** - Carpet casters
 - S** - Hard floor casters
 - GL** - Glides
 - SCG** - Front hard floor casters, rear glides
 - CCG** - Front carpet casters, rear glides
- F** Select upholstery grade/color. Refer to ki.com/fabrics

UPHOLSTERY INFORMATION

C.O.M. Upholstery
 C.O.M. requirement is 5/8 yard per chair for seat of 54" wide nondirectional fabric. For complete information on ordering C.O.M. see "Ordering C.O.M., C.O.V. and C.O.L." section.

California TB133 Fire Safety Code
 For California Technical Bulletin 133 compliant models, add the following upcharge:
 Model=Polypropylene
 Added List Price=\$28
 Model=Upholstered Seat
 Added List Price=\$83

SPECIAL SERVICES

Special Carton Marking

With specially marked information N/C

Shipping
 Ships **assembled, FOB Green Bay, WI 54302, freight prepaid.** Freight class 300.

Specifications and prices are subject to change without prior notice.

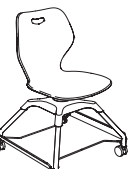

| MODEL | Features | MODEL NUMBER | | | | | | Approx. Packaged Weight | Delivered Pricing | Delivered Pricing Fabric Grade 1, C.O.M. & COV | Delivered Pricing Fabric Grade 2 | Delivered Pricing Fabric Grade 3 & Group 2V Vinyl | Delivered Pricing Pallas Fabric Group P0 | Delivered Pricing Pallas Fabric Group P1 | Delivered Pricing Pallas Fabric Group P2 | Delivered Pricing Pallas Fabric Group P3 | Delivered Pricing Pallas Fabric Group P4 |
|-----------------------------------------------------------------------------------------------------|-------------------------------------------------------------------------------------------------------------------------------------------------------------------------------------------------|------------------|-------------|--------------------------|--------------------------|--------------------------|--------------------------|--------------------------|-------------------|------------------------------------------------|----------------------------------|---------------------------------------------------|------------------------------------------|------------------------------------------|------------------------------------------|------------------------------------------|------------------------------------------|
| | | Basic Model | Frame Color | Fire Code | Shell Color | Glide Option | Upholstery Color | | | | | | | | | | |
|  2WNSP 2WNSU | No Worksurface - Poly Bookbag Rack • Poly bookbag rack included • Poly bookbag rack includes two accessory slots and a cupholder • Poly Bookbag rack is only available in black | Polypropylene | L2WNP/PBR | <input type="checkbox"/> | <input type="checkbox"/> | <input type="checkbox"/> | <input type="checkbox"/> | 42.0# | \$ 604 | | | | | | | | |
| | | Upholstered Seat | L2WNUS/PBR | <input type="checkbox"/> | <input type="checkbox"/> | <input type="checkbox"/> | <input type="checkbox"/> | <input type="checkbox"/> | 45.0# | N/A | 676 | 682 | 692 | 682 | 730 | 750 | 770 |
|  2WNSP 2WNSU | No Worksurface - Flat Accessory Rack • Flat accessory rack included | Polypropylene | L2WNP/FBR | <input type="checkbox"/> | <input type="checkbox"/> | <input type="checkbox"/> | <input type="checkbox"/> | 42.0# | \$ 623 | | | | | | | | |
| | | Upholstered Seat | L2WNUS/FBR | <input type="checkbox"/> | <input type="checkbox"/> | <input type="checkbox"/> | <input type="checkbox"/> | <input type="checkbox"/> | 45.0# | N/A | 695 | 700 | 713 | 700 | 753 | 768 | 790 |

A **B** **C** **D** **E** **F**

HOW TO ORDER

- Indicate the following information on order form:
- Quantity of each item.
 - Model number, including options. See "How To Build a Model Number".
 - Any special service required.

Note: • The indicates that a choice is required.
 • The absence of the indicates that no choice is required.
 • Alpha-numeric characters in place of indicate that no other alternatives are available.

HOW TO BUILD A MODEL NUMBER

- A** Select basic model.
- B** Select frame color. Refer to the **Product Color Options** page in this price list.
- C** Select fire code.
 - FR** - Compliance to TB 133
 - NFR** - Compliance to TB 117-2013
 See Upholstery Information for TB133 upcharge.
- D** Select shell color. Refer to the **Product Color Options** page in this price list.
- E** Select caster/glide option.
 - C** - Carpet casters
 - S** - Hard floor casters
 - GL** - Glides
 - SCG** - Front hard floor casters, rear glides
 - CCG** - Front carpet casters, rear glides
- F** Select upholstery grade/color. Refer to ki.com/fabrics

UPHOLSTERY INFORMATION

C.O.M. Upholstery
 C.O.M. requirement is 5/8 yard per chair for seat of 54" wide nondirectional fabric. For complete information on ordering C.O.M. see "Ordering C.O.M., C.O.V. and C.O.L." section.

California TB133 Fire Safety Code
 For California Technical Bulletin 133 compliant models, add the following upcharge:
 Model=Polypropylene
 Added List Price=\$28
 Model=Upholstered Seat
 Added List Price=\$83

FINISH INFORMATION

Poly Bookbag Rack comes standard in Black. Other KI standard poly colors are available through a Product Modification Request. No upcharge or fees apply for orders of 20 or more. A net setup fee applies for orders of 19 or less. Please allow up 1 week additional leadtime.

SPECIAL SERVICES

Special Carton Marking



With specially marked information N/C

Shipping

Ships assembled, FOB Green Bay, WI 54302, freight prepaid. Freight class 300.

Specifications and prices are subject to change without prior notice.



| MODEL | Features | MODEL NUMBER | | | | | | Approx. Packaged Weight | Delivered Pricing | Delivered Pricing Fabric Grade 1, C.O.M. & COV | Delivered Pricing Fabric Grade 2 | Delivered Pricing Fabric Grade 3 & Group 2V Vinyl | Delivered Pricing Pallas Fabric Group P0 | Delivered Pricing Pallas Fabric Group P1 | Delivered Pricing Pallas Fabric Group P2 | Delivered Pricing Pallas Fabric Group P3 | Delivered Pricing Pallas Fabric Group P4 |
|-----------------------------------------------------------------------------------------------------|---------------------------------------------------------------------------------------------------------------------------------------------------------------------------------------------------|--------------|--------------------------|--------------------------|--------------------------|--------------------------|--------------------------|-------------------------|-------------------|------------------------------------------------|----------------------------------|---------------------------------------------------|------------------------------------------|------------------------------------------|------------------------------------------|------------------------------------------|------------------------------------------|
| | | Basic Model | Frame Color | Fire Code | Shell Color | Glide Option | Uph. Color | | | | | | | | | | |
|  2LNS1 2LNS2 | No Worksurface - Without Accessory Rack Polypropylene Upholstered Seat • One-piece shell • Passive back flex | L2LN1/NA/NAR | <input type="checkbox"/> | <input type="checkbox"/> | <input type="checkbox"/> | <input type="checkbox"/> | 45.0# | \$ 698 | | | | | | | | | |
| | | L2LN2/NA/NAR | <input type="checkbox"/> | <input type="checkbox"/> | <input type="checkbox"/> | <input type="checkbox"/> | <input type="checkbox"/> | 47.0# | N/A | 773 | 773 | 806 | 814 | 866 | 889 | 916 | 938 |
|  2LNS1 2LNS2 | No Worksurface - Accessory Rack Polypropylene Upholstered Seat • One-piece shell • Passive back flex • Accessory rack included on both sides of frame | L2LN1/NA/SAR | <input type="checkbox"/> | <input type="checkbox"/> | <input type="checkbox"/> | <input type="checkbox"/> | 53.0# | \$ 726 | | | | | | | | | |
| | | L2LN2/NA/SAR | <input type="checkbox"/> | <input type="checkbox"/> | <input type="checkbox"/> | <input type="checkbox"/> | <input type="checkbox"/> | 55.0# | N/A | 801 | 834 | 851 | 842 | 894 | 917 | 944 | 966 |
|  2LNS1 2LNS2 | No Worksurface - Cup Holder/Accessory Rack Polypropylene Upholstered Seat • One-piece shell • Passive back flex • Cup holder/accessory rack included on both sides of frame | L2LN1/NA/CAR | <input type="checkbox"/> | <input type="checkbox"/> | <input type="checkbox"/> | <input type="checkbox"/> | 53.0# | \$ 774 | | | | | | | | | |
| | | L2LN2/NA/CAR | <input type="checkbox"/> | <input type="checkbox"/> | <input type="checkbox"/> | <input type="checkbox"/> | <input type="checkbox"/> | 55.0# | N/A | 851 | 884 | 901 | 892 | 944 | 967 | 994 | 1016 |

A **B** **C** **D** **E** **F**

HOW TO ORDER

- Indicate the following information on order form:
- Quantity of each item.
 - Model number, including options. See "How To Build a Model Number".
 - Any special service required.

Note: • The indicates that a choice is required.
 • The absence of the indicates that no choice is required.
 • Alpha-numeric characters in place of indicate that no other alternatives are available.

HOW TO BUILD A MODEL NUMBER

- A** Select basic model.
- B** Select frame color.
Refer to the **Product Color Options** page in this price list.
- C** Select fire code.

| | |
|------------|-----------------------------|
| NFR | - Compliance to TB 117-2013 |
| FR | - Compliance to TB 133 |

 See Upholstery Information for TB133 upcharge.
- D** Select poly seat and back color.
Refer to the **Product Color Options** page in this price list.
- E** Select caster/glide option.

| | |
|------------|-----------------------------------------|
| C | - Carpet casters |
| S | - Hard floor casters |
| GL | - Glides |
| SCG | - Front hard floor casters, rear glides |
| CCG | - Front carpet casters, rear glides |

F Select upholstery grade/color.
Refer to ki.com/fabrics

UPHOLSTERY INFORMATION

C.O.M. Upholstery
 C.O.M. requirement for 10 chairs or less with upholstered seat or upholstered seat and back is 3/4 yard per chair of 54" wide nondirectional fabric. For orders of 11 or more with upholstered seat and back and for complete information on ordering C.O.M. see "Ordering C.O.M., C.O.V. and C.O.L." section.

California TB133 Fire Safety Code
 For California Technical Bulletin 133 compliant models, add the following upcharge:
 Model=Polypropylene
 Added List Price=\$13
 Model=Upholstered Seat
 Added List Price=\$85

SPECIAL SERVICES



Special Carton Marking

With specially marked information N/C

Shipping
 Ships assembled, FOB Green Bay, WI 54302, freight prepaid. Freight class 300.

Specifications and prices are subject to change without prior notice.



| MODEL | Features | MODEL NUMBER | | | | | | Approx. Packaged Weight | Delivered Pricing | Delivered Pricing Fabric Grade 1, C.O.M. & COV | Delivered Pricing Fabric Grade 2 | Delivered Pricing Fabric Grade 3 & Group 2V Vinyl | Delivered Pricing Pallas Fabric Group P0 | Delivered Pricing Pallas Fabric Group P1 | Delivered Pricing Pallas Fabric Group P2 | Delivered Pricing Pallas Fabric Group P3 | Delivered Pricing Pallas Fabric Group P4 |
|-----------------------------------------------------------------------------------------------------|---------------------------------------------------------------------------------------------------------------------------------------------------------------------------------------------------------------------------------------------|------------------|--------------|--------------------------|--------------------------|--------------------------|--------------------------|--------------------------|-------------------|------------------------------------------------|----------------------------------|---------------------------------------------------|------------------------------------------|------------------------------------------|------------------------------------------|------------------------------------------|------------------------------------------|
| | | Basic Model | Frame Color | Fire Code | Shell Color | Glide Option | Uph. Color | | | | | | | | | | |
|  2LNS1 2LNS2 | No Worksurface - Poly Bookbag Rack • One-piece shell • Passive back flex • Poly bookbag rack included • Poly bookbag rack includes two accessory slots and a cupholder • Poly Bookbag rack is only available in black | Polypropylene | L2LN1/NA/PBR | <input type="checkbox"/> | <input type="checkbox"/> | <input type="checkbox"/> | <input type="checkbox"/> | 49.0# | \$ 756 | | | | | | | | |
| | | Upholstered Seat | L2LN2/NA/PBR | <input type="checkbox"/> | <input type="checkbox"/> | <input type="checkbox"/> | <input type="checkbox"/> | <input type="checkbox"/> | 51.0# | N/A | 830 | 863 | 880 | 871 | 923 | 946 | 973 |
|  2LNS1 2LNS2 | No Worksurface - Flat Accessory Rack • One-piece shell • Passive back flex • Flat accessory rack included | Polypropylene | L2LN1/NA/FBR | <input type="checkbox"/> | <input type="checkbox"/> | <input type="checkbox"/> | <input type="checkbox"/> | 55.0# | \$ 774 | | | | | | | | |
| | | Upholstered Seat | L2LN2/NA/FBR | <input type="checkbox"/> | <input type="checkbox"/> | <input type="checkbox"/> | <input type="checkbox"/> | <input type="checkbox"/> | 57.0# | N/A | 851 | 884 | 901 | 892 | 944 | 967 | 994 |

A **B** **C** **D** **E** **F**

HOW TO ORDER

- Indicate the following information on order form:
- Quantity of each item.
 - Model number, including options. See "How To Build a Model Number".
 - Any special service required.

Note:

- The indicates that a choice is required.
- The absence of the indicates that no choice is required.
- Alpha-numeric characters in place of indicate that no other alternatives are available.

HOW TO BUILD A MODEL NUMBER

- A** Select basic model.
- B** Select frame color. Refer to the **Product Color Options** page in this price list.
- C** Select fire code.
 - NFR** - Compliance to TB 117-2013
 - FR** - Compliance to TB 133
 See Upholstery Information for TB133 upcharge.
- D** Select poly seat and back color. Refer to the **Product Color Options** page in this price list.
- E** Select caster/glide option.
 - C** - Carpet casters
 - S** - Hard floor casters
 - GL** - Glides
 - SCG** - Front hard floor casters, rear glides
 - CCG** - Front carpet casters, rear glides
- F** Select upholstery grade/color. Refer to ki.com/fabrics

UPHOLSTERY INFORMATION

C.O.M. Upholstery
 C.O.M. requirement for 10 chairs or less with upholstered seat or upholstered seat and back is 3/4 yard per chair of 54" wide nondirectional fabric. For orders of 11 or more with upholstered seat and back and for complete information on ordering C.O.M. see "Ordering C.O.M., C.O.V. and C.O.L." section.

California TB133 Fire Safety Code
 For California Technical Bulletin 133 compliant models, add the following upcharge:
 Model=Polypropylene
 Added List Price=\$13
 Model=Upholstered Seat
 Added List Price=\$85

FINISH INFORMATION

Poly Bookbag Rack comes standard in Black. Other KI standard poly colors are available through a Product Modification Request. No upcharge or fees apply for orders of 20 or more. A net setup fee applies for orders of 19 or less. Please allow up 1 week additional leadtime.

SPECIAL SERVICES

Special Carton Marking



With specially marked information N/C

Shipping

Ships assembled, FOB Green Bay, WI 54302, freight prepaid. Freight class 300.

Specifications and prices are subject to change without prior notice.



| MODEL | Features | MODEL NUMBER | | | | | | Approx. Packaged Weight | Delivered Pricing | Delivered Pricing Fabric Grade 1, C.O.M. & COV | Delivered Pricing Fabric Grade 2 | Delivered Pricing Fabric Grade 3 & Group 2V Vinyl | Delivered Pricing Pallas Fabric Group P0 | Delivered Pricing Pallas Fabric Group P1 | Delivered Pricing Pallas Fabric Group P2 | Delivered Pricing Pallas Fabric Group P3 | Delivered Pricing Pallas Fabric Group P4 |
|------------------------------------------------------------------------------------------------------|------------------------------------------------------------------------------------------------------------------|------------------|---------------|--------------------------|--------------------------|--------------------------|--------------------------|-------------------------|-------------------|------------------------------------------------|----------------------------------|---------------------------------------------------|------------------------------------------|------------------------------------------|------------------------------------------|------------------------------------------|------------------------------------------|
| | | Basic Model | Frame Color | Fire Code | Shell Color | Glide Option | Upholstery Color | | | | | | | | | | |
|  2SNSP 2SNSU | No Worksurface - Without Accessory Rack | Polypropylene | L2SNP/NA/NAR | <input type="checkbox"/> | <input type="checkbox"/> | <input type="checkbox"/> | <input type="checkbox"/> | 44.0# | \$ 692 | | | | | | | | |
| | | Upholstered Seat | L2SNUS/NA/NAR | <input type="checkbox"/> | <input type="checkbox"/> | <input type="checkbox"/> | <input type="checkbox"/> | 47.0# | N/A | 767 | 804 | 818 | 811 | 861 | 887 | 912 | 934 |
|  2SNSP 2SNSU | No Worksurface - Accessory Rack • Accessory rack included on both sides of frame | Polypropylene | L2SNP/NA/SAR | <input type="checkbox"/> | <input type="checkbox"/> | <input type="checkbox"/> | <input type="checkbox"/> | 53.0# | \$ 720 | | | | | | | | |
| | | Upholstered Seat | L2SNUS/NA/SAR | <input type="checkbox"/> | <input type="checkbox"/> | <input type="checkbox"/> | <input type="checkbox"/> | 56.0# | N/A | 795 | 831 | 848 | 838 | 890 | 916 | 940 | 965 |
|  2SNSP 2SNSU | No Worksurface - Cup Holder/Accessory Rack • Cup holder/accessory rack included on both sides of frame | Polypropylene | L2SNP/NA/CAR | <input type="checkbox"/> | <input type="checkbox"/> | <input type="checkbox"/> | <input type="checkbox"/> | 53.0# | \$ 768 | | | | | | | | |
| | | Upholstered Seat | L2SNUS/NA/CAR | <input type="checkbox"/> | <input type="checkbox"/> | <input type="checkbox"/> | <input type="checkbox"/> | 56.0# | N/A | 845 | 881 | 896 | 888 | 938 | 965 | 989 | 1012 |

A **B** **C** **D** **E** **F**

HOW TO ORDER

- Indicate the following information on order form:
- Quantity of each item.
 - Model number, including options. See "How To Build a Model Number".
 - Any special service required.

Note: • The indicates that a choice is required.
 • The absence of the indicates that no choice is required.
 • Alpha-numeric characters in place of indicate that no other alternatives are available.

HOW TO BUILD A MODEL NUMBER

- A** Select basic model.
- B** Select frame color. Refer to the **Product Color Options** page in this price list.
- C** Select fire code.
 - FR** - Compliance to TB 133
 - NFR** - Compliance to TB 117-2013
 See Upholstery Information for TB133 upcharge.
- D** Select poly seat and back color. Refer to the **Product Color Options** page in this price list.
- E** Select caster/glide option.
 - C** - Carpet casters
 - S** - Hard floor casters
 - GL** - Glides
 - SCG** - Front hard floor casters, rear glides
 - CCG** - Front carpet casters, rear glides
- F** Select upholstery grade/color. Refer to ki.com/fabrics

UPHOLSTERY INFORMATION

C.O.M. Upholstery
 C.O.M. requirement for 10 chairs or less with upholstered seat or upholstered seat and back is 3/4 yard per chair of 54" wide nondirectional fabric. For orders of 11 or more with upholstered seat and back and for complete information on ordering C.O.M. see "Ordering C.O.M., C.O.V. and C.O.L." section.

California TB133 Fire Safety Code
 For California Technical Bulletin 133 compliant models, add the following upcharge:
 Model=Polypropylene
 Added List Price=\$13
 Model=Upholstered Seat
 Added List Price=\$85



SPECIAL SERVICES

Special Carton Marking
 With specially marked information N/C

Shipping
 Ships **assembled, FOB Green Bay, WI 54302, freight prepaid.** Freight class 300.

Specifications and prices are subject to change without prior notice.



| MODEL | Features | MODEL NUMBER | | | | | | Approx. Packaged Weight | Delivered Pricing | Delivered Pricing Fabric Grade 1, C.O.M. & COV | Delivered Pricing Fabric Grade 2 | Delivered Pricing Fabric Grade 3 & Group 2V Vinyl | Delivered Pricing Pallas Fabric Group P0 | Delivered Pricing Pallas Fabric Group P1 | Delivered Pricing Pallas Fabric Group P2 | Delivered Pricing Pallas Fabric Group P3 | Delivered Pricing Pallas Fabric Group P4 |
|-----------------------------------------------------------------------------------------------------------------------------------------------------------------------------------------------------------------------------------------------------------------------------------------------------------------------------------------------------|------------------|---------------|--------------------------|--------------------------|--------------------------|--------------------------|------------------|-------------------------|-------------------|------------------------------------------------|----------------------------------|---------------------------------------------------|------------------------------------------|------------------------------------------|------------------------------------------|------------------------------------------|------------------------------------------|
| | | Basic Model | Frame Color | Fire Code | Shell Color | Glide Option | Upholstery Color | | | | | | | | | | |
|  <p>No Worksurface - Poly Bookbag Rack</p> <ul style="list-style-type: none"> • Poly bookbag rack included • Poly bookbag rack includes two accessory slots and a cupholder • Poly Bookbag rack is only available in black | Polypropylene | L2SNP/NA/PBR | <input type="checkbox"/> | <input type="checkbox"/> | <input type="checkbox"/> | <input type="checkbox"/> | 53.0# | \$ 750 | | | | | | | | | |
| | Upholstered Seat | L2SNUS/NA/PBR | <input type="checkbox"/> | <input type="checkbox"/> | <input type="checkbox"/> | <input type="checkbox"/> | 56.0# | N/A | 824 | 860 | 875 | 869 | 918 | 944 | 969 | 991 | |
| 2SNSP | | | | | | | | | | | | | | | | | |
| 2SNSU | | | | | | | | | | | | | | | | | |
|  <p>No Worksurface - Flat Accessory Rack</p> <ul style="list-style-type: none"> • Flat accessory rack included | Polypropylene | L2SNP/NA/FBR | <input type="checkbox"/> | <input type="checkbox"/> | <input type="checkbox"/> | <input type="checkbox"/> | 53.0# | \$ 768 | | | | | | | | | |
| | Upholstered Seat | L2SNUS/NA/FBR | <input type="checkbox"/> | <input type="checkbox"/> | <input type="checkbox"/> | <input type="checkbox"/> | 56.0# | N/A | 845 | 881 | 896 | 888 | 938 | 965 | 989 | 1012 | |
| 2SNSP | | | | | | | | | | | | | | | | | |
| 2SNSU | | | | | | | | | | | | | | | | | |

A **B** **C** **D** **E** **F**

HOW TO ORDER

- Indicate the following information on order form:
1. Quantity of each item.
 2. Model number, including options. See "How To Build a Model Number".
 3. Any special service required.

Note:

- The indicates that a choice is required.
- The absence of the indicates that no choice is required.
- Alpha-numeric characters in place of indicate that no other alternatives are available.

HOW TO BUILD A MODEL NUMBER

- A** Select basic model.
- B** Select frame color. Refer to the **Product Color Options** page in this price list.
- C** Select fire code.
 - FR** - Compliance to TB 133
 - NFR** - Compliance to TB 117-2013
 See Upholstery Information for TB133 upcharge.
- D** Select poly seat and back color. Refer to the **Product Color Options** page in this price list.
- E** Select caster/glide option.
 - C** - Carpet casters
 - S** - Hard floor casters
 - GL** - Glides
 - SCG** - Front hard floor casters, rear glides
 - CCG** - Front carpet casters, rear glides

F Select upholstery grade/color. Refer to ki.com/fabrics

UPHOLSTERY INFORMATION

C.O.M. Upholstery
 C.O.M. requirement for 10 chairs or less with upholstered seat or upholstered seat and back is 3/4 yard per chair of 54" wide nondirectional fabric. For orders of 11 or more with upholstered seat and back and for complete information on ordering C.O.M. see "Ordering C.O.M., C.O.V. and C.O.L." section.

California TB133 Fire Safety Code
 For California Technical Bulletin 133 compliant models, add the following upcharge:
 Model=Polypropylene
 Added List Price=\$13
 Model=Upholstered Seat
 Added List Price=\$85

FINISH INFORMATION

Poly Bookbag Rack comes standard in Black. Other KI standard poly colors are available through a Product Modification Request. No upcharge or fees apply for orders of 20 or more. A net setup fee applies for orders of 19 or less. Please allow up 1 week additional leadtime.

SPECIAL SERVICES



Special Carton Marking

With specially marked information N/C

Shipping
 Ships **assembled, FOB Green Bay, WI 54302, freight prepaid.** Freight class 300.

Specifications and prices are subject to change without prior notice.



| MODEL | Features | MODEL NUMBER | | | | | | Approx. Packaged Weight | Delivered Pricing | Delivered Pricing Fabric Grade 1, C.O.M. & COV | Delivered Pricing Fabric Grade 2 | Delivered Pricing Fabric Grade 3 & Group 2V Vinyl | Delivered Pricing Pallas Fabric Group P0 | Delivered Pricing Pallas Fabric Group P1 | Delivered Pricing Pallas Fabric Group P2 | Delivered Pricing Pallas Fabric Group P3 | Delivered Pricing Pallas Fabric Group P4 |
|---------------------------------------------------------------------------------------------------------------------------------------------------------------------------------------------------------------|------------------|---------------|--------------------------|--------------------------|--------------------------|--------------------------|------------------|-------------------------|-------------------|------------------------------------------------|----------------------------------|---------------------------------------------------|------------------------------------------|------------------------------------------|------------------------------------------|------------------------------------------|------------------------------------------|
| | | Basic Model | Frame Color | Fire Code | Shell Color | Glide Option | Upholstery Color | | | | | | | | | | |
|  No Worksurface - Armchair without Accessory Rack | Polypropylene | L2SNP/CA/NAR | <input type="checkbox"/> | <input type="checkbox"/> | <input type="checkbox"/> | <input type="checkbox"/> | 47.0# | \$ 765 | | | | | | | | | |
| | Upholstered Seat | L2SNUS/CA/NAR | <input type="checkbox"/> | <input type="checkbox"/> | <input type="checkbox"/> | <input type="checkbox"/> | 50.0# | N/A | 838 | 874 | 890 | 898 | 949 | 959 | 985 | 1007 | |
| 2SNSP 2SNSU | | | | | | | | | | | | | | | | | |
|  No Worksurface - Armchair with Accessory Rack • Accessory rack included on both sides of frame | Polypropylene | L2SNP/CA/SAR | <input type="checkbox"/> | <input type="checkbox"/> | <input type="checkbox"/> | <input type="checkbox"/> | 56.0# | \$ 793 | | | | | | | | | |
| | Upholstered Seat | L2SNUS/CA/SAR | <input type="checkbox"/> | <input type="checkbox"/> | <input type="checkbox"/> | <input type="checkbox"/> | 59.0# | N/A | 869 | 904 | 920 | 912 | 965 | 987 | 1016 | 1035 | |
| 2SNSP 2SNSU | | | | | | | | | | | | | | | | | |
|  No Worksurface - Armchair with Cup Holder/Accessory Rack • Cup holder/accessory rack included on both sides of frame | Polypropylene | L2SNP/CA/CAR | <input type="checkbox"/> | <input type="checkbox"/> | <input type="checkbox"/> | <input type="checkbox"/> | 56.0# | \$ 841 | | | | | | | | | |
| | Upholstered Seat | L2SNUS/CA/CAR | <input type="checkbox"/> | <input type="checkbox"/> | <input type="checkbox"/> | <input type="checkbox"/> | 59.0# | N/A | 917 | 951 | 968 | 960 | 1012 | 1035 | 1062 | 1084 | |
| 2SNSP 2SNSU | | | | | | | | | | | | | | | | | |

A **B** **C** **D** **E** **F**

HOW TO ORDER

- Indicate the following information on order form:
- Quantity of each item.
 - Model number, including options. See "How To Build a Model Number".
 - Any special service required.

Note: • The indicates that a choice is required.
 • The absence of the indicates that no choice is required.
 • Alpha-numeric characters in place of indicate that no other alternatives are available.

HOW TO BUILD A MODEL NUMBER

- A** Select basic model.
- B** Select frame color. Refer to the **Product Color Options** page in this price list.
- C** Select fire code.

| | |
|------------|-----------------------------|
| NFR | - Compliance to TB 117-2013 |
| FR | - Compliance to TB 133 |

 See Upholstery Information for TB133 upcharge.
- D** Select poly seat and back color. Refer to the **Product Color Options** page in this price list.
- E** Select caster/glide option.

| | |
|------------|-----------------------------------------|
| C | - Carpet casters |
| S | - Hard floor casters |
| GL | - Glides |
| SCG | - Front hard floor casters, rear glides |
| CCG | - Front carpet casters, rear glides |

F Select upholstery grade/color. Refer to ki.com/fabrics

UPHOLSTERY INFORMATION

C.O.M. Upholstery
 C.O.M. requirement for 10 chairs or less with upholstered seat or upholstered seat and back is 3/4 yard per chair of 54" wide nondirectional fabric. For orders of 11 or more with upholstered seat and back and for complete information on ordering C.O.M. see "Ordering C.O.M., C.O.V. and C.O.L." section.

California TB133 Fire Safety Code
 For California Technical Bulletin 133 compliant models, add the following upcharge:
 Model=Polypropylene
 Added List Price=\$13
 Model=Upholstered Seat
 Added List Price=\$85

SPECIAL SERVICES



Special Carton Marking

With specially marked information N/C

Shipping
 Ships **assembled, FOB Green Bay, WI 54302, freight prepaid.** Freight class 300.

Specifications and prices are subject to change without prior notice.



| MODEL | Features | MODEL NUMBER | | | | | | Approx. Packaged Weight | Delivered Pricing | Delivered Pricing Fabric Grade 1, C.O.M. & COV | Delivered Pricing Fabric Grade 2 | Delivered Pricing Fabric Grade 3 & Group 2V Vinyl | Delivered Pricing Pallas Fabric Group P0 | Delivered Pricing Pallas Fabric Group P1 | Delivered Pricing Pallas Fabric Group P2 | Delivered Pricing Pallas Fabric Group P3 | Delivered Pricing Pallas Fabric Group P4 |
|-------------------------------------------------------------------------------------------------------------------------------------------------------------------------------------------------------------------------------------------------------------------------------------------------------------------------------------------------------------------|------------------|---------------|--------------------------|--------------------------|--------------------------|--------------------------|------------------|-------------------------|-------------------|------------------------------------------------|----------------------------------|---------------------------------------------------|------------------------------------------|------------------------------------------|------------------------------------------|------------------------------------------|------------------------------------------|
| | | Basic Model | Frame Color | Fire Code | Shell Color | Glide Option | Upholstery Color | | | | | | | | | | |
|  <p>No Worksurface - Armchair with Poly Bookbag Rack</p> <ul style="list-style-type: none"> • Poly bookbag rack included • Poly bookbag rack includes two accessory slots and a cupholder • Poly Bookbag rack is only available in black | Polypropylene | L2SNP/CA/PBR | <input type="checkbox"/> | <input type="checkbox"/> | <input type="checkbox"/> | <input type="checkbox"/> | 56.0# | \$ 821 | | | | | | | | | |
| | Upholstered Seat | L2SNUS/CA/PBR | <input type="checkbox"/> | <input type="checkbox"/> | <input type="checkbox"/> | <input type="checkbox"/> | 59.0# | N/A | 896 | 931 | 947 | 956 | 1007 | 1017 | 1041 | 1063 | |
| 2SNSP 2SNSU | | | | | | | | | | | | | | | | | |
|  <p>No Worksurface - Armchair with Flat Accessory Rack</p> <ul style="list-style-type: none"> • Flat accessory rack included | Polypropylene | L2SNP/CA/FBR | <input type="checkbox"/> | <input type="checkbox"/> | <input type="checkbox"/> | <input type="checkbox"/> | 56.0# | \$ 841 | | | | | | | | | |
| | Upholstered Seat | L2SNUS/CA/FBR | <input type="checkbox"/> | <input type="checkbox"/> | <input type="checkbox"/> | <input type="checkbox"/> | 59.0# | N/A | 917 | 951 | 968 | 960 | 1012 | 1035 | 1062 | 1084 | |
| 2SNSP 2SNSU | | | | | | | | | | | | | | | | | |

A **B** **C** **D** **E** **F**

HOW TO ORDER

- Indicate the following information on order form:
1. Quantity of each item.
 2. Model number, including options. See "How To Build a Model Number".
 3. Any special service required.

Note:

- The indicates that a choice is required.
- The absence of the indicates that no choice is required.
- Alpha-numeric characters in place of indicate that no other alternatives are available.

HOW TO BUILD A MODEL NUMBER

- A** Select basic model.
- B** Select frame color. Refer to the **Product Color Options** page in this price list.
- C** Select fire code.
 - FR** - Compliance to TB 133
 - NFR** - Compliance to TB 117-2013
 See Upholstery Information for TB133 upcharge.
- D** Select poly seat and back color. Refer to the **Product Color Options** page in this price list.
- E** Select caster/glide option.
 - C** - Carpet casters
 - S** - Hard floor casters
 - GL** - Glides
 - SCG** - Front hard floor casters, rear glides
 - CCG** - Front carpet casters, rear glides

F Select upholstery grade/color. Refer to ki.com/fabrics

UPHOLSTERY INFORMATION

C.O.M. Upholstery
 C.O.M. requirement for 10 chairs or less with upholstered seat or upholstered seat and back is 3/4 yard per chair of 54" wide nondirectional fabric. For orders of 11 or more with upholstered seat and back and for complete information on ordering C.O.M. see "Ordering C.O.M., C.O.V. and C.O.L." section.

California TB133 Fire Safety Code
 For California Technical Bulletin 133 compliant models, add the following upcharge:
 Model=Polypropylene
 Added List Price=\$13
 Model=Upholstered Seat
 Added List Price=\$85

FINISH INFORMATION

Poly Bookbag Rack comes standard in Black. Other KI standard poly colors are available through a Product Modification Request. No upcharge or fees apply for orders of 20 or more. A net setup fee applies for orders of 19 or less. Please allow up 1 week additional leadtime.

SPECIAL SERVICES

Special Carton Marking

With specially marked information N/C

Shipping
 Ships **assembled, FOB Green Bay, WI 54302, freight prepaid.** Freight class 300.

Specifications and prices are subject to change without prior notice.



1330 BELLEVUE STREET
GREEN BAY, WI 54302
800.424.2432 / KI.COM

KI is a trusted expert for furniture and wall systems around the globe.
USA | CANADA | MEXICO | UK | EUROPE | ASIA | MIDDLE EAST
© 2024 Krueger International, Inc. All Rights Reserved.